

**HONDA**  
The Power of Dreams

**CR-V**

31TLG10  
OG-10217  
00X31-TLA-G102

[owners.honda.com](http://owners.honda.com) (U.S.)  
[myhonda.ca](http://myhonda.ca) (Canada)

2018 Honda CR-V Owner's Guide  
©2018 Honda Motor Co., Ltd. — All Rights Reserved

Printed in U.S.A.

 **HONDA**

**2018**  
**OWNER'S GUIDE**

# DISCLOSURES

## ■ Devices That Emit Radio Waves

The following products and systems on your vehicle emit radio waves when in operation:

- Audio system
- Blind spot information system
- Bluetooth® Audio
- Bluetooth® HandsFreeLink®
- HomeLink® Universal Transceiver\*
- Collision Mitigation Braking System™ (CMBS™)\*
- Immobilizer system
- Remote engine starter\*
- Remote transmitter\*
- Keyless Access System\*
- Tire Pressure Monitoring System

Each of the above complies with the appropriate requirements or the required standards of the FCC (Federal Communications Commission) and Industry Canada, described below:

*As required by the FCC:*

This device complies with Part 15 of the FCC rules. Operation is subject to the following two conditions: (1) This device may not cause harmful interference, and (2) this device must accept any interference received, including interference that may cause undesired operation.

Changes or modifications not expressly approved by the party responsible for compliance could void the user's authority to operate the equipment.

*As required by Industry Canada:*

This device complies with Industry Canada licence-exempt RSS standard(s). Operation is subject to the following two conditions: (1) this device may not cause interference, and (2) this device must accept any interference, including interference that may cause undesired operation of the device.

## ■ Disclaimer

The information and data contained herein are believed to be accurate and reliable. American Honda Motor Co., Inc. makes no warranty of any kind and accepts no responsibility for the results obtained through application of this information.

## ■ Privacy Notice

This vehicle may share location and usage information. To manage this setting, visit [www.hondalink.com/vehicle-data-choices](http://www.hondalink.com/vehicle-data-choices) (US) or [honda.ca/hondalinkassist](http://honda.ca/hondalinkassist) (Canada).

## ■ Event Data Recorders

**This vehicle is equipped with an event data recorder (EDR).** The main purpose of an EDR is to record, in certain crash or near crash-like situations, such as an air bag deployment or hitting a road obstacle, data that will assist in understanding how a vehicle's systems performed. **The EDR is designed to record data related to vehicle dynamics and safety systems for a short period of time, typically 30 seconds or less. The EDR in this vehicle is designed to record such data as:**

- **How various systems in your vehicle were operating;**
- **Whether or not the driver and passenger safety belts were buckled/fastened;**
- **How far (if at all) the driver was depressing the accelerator and/or brake pedal; and,**
- **How fast the vehicle was traveling.**

These data can help provide a better understanding of the circumstances in which crashes and injuries occur. NOTE: EDR data are recorded by your vehicle only if a non-trivial crash situation occurs; no data are recorded by the EDR under normal driving conditions and no personal data (e.g., name, gender, age, and crash location) are recorded. However, other parties, such as law enforcement, could combine the EDR data with the type of personally identifying data routinely acquired during a crash investigation.

To read data recorded by an EDR, special equipment is required, and access to the vehicle or the EDR is needed. In addition to the vehicle manufacturer, other parties such as law enforcement that have the special equipment can read the information if they have access to the vehicle or the EDR.

The data belong to the vehicle owner and may not be accessed by anyone else except as legally required or with the permission of the vehicle owner.

## ■ Service Diagnostic Recorders

This vehicle is equipped with service-related devices that record information about powertrain performance. The data can be used to verify emissions law requirements and/or help technicians diagnose and solve service problems. It may also be combined with data from other sources for research purposes, but it remains confidential. Some diagnostic and maintenance information is uploaded to Honda upon vehicle start up.

# INTRODUCTION

This Owner's Guide is intended to help you quickly get acquainted with your **2018 Honda CR-V**. It provides basic information and instructions on technology and convenience features, as well as emergency procedures and how to get assistance.

This guide is for vehicles sold in the United States and Canada. It covers all CR-V models, so you may find descriptions of features and equipment that are not in your vehicle. Images throughout this guide are from U.S. vehicles and represent features and equipment that are available on some, but not all, models.

This guide is not intended to be a substitute for the Owner's Manual at *owners.honda.com* (U.S.) or *myhonda.ca* (Canada). The Warranty Information CD enclosed in your glove box kit includes the vehicle and tire warranties in electronic format. This information can be viewed on a computer (PC or Mac platform) and saved or printed for your reference. You can also visit *owners.honda.com* (U.S.) or *myhonda.ca* (Canada) to view the complete and most current information.

If you are the first registered owner of your vehicle, you may request a complimentary printed copy of the Owner's Manual, Navigation Manual, or Vehicle Warranty within the first six months of vehicle purchase. To request a copy, visit *owners.honda.com* (U.S.) and create or log in to your account. In Canada, please request a copy from your Honda dealer.

American Honda Motor Co., Inc. strives to be proactive in protecting our environment and natural resources. By using electronic delivery for a considerable portion of the information typically found in a vehicle owner's manual, we are further reducing our impact on the environment.

## Honda Automobile Customer Service

Your authorized Honda dealer should be able to answer any questions you have about your vehicle. However, if you are dissatisfied with the information you receive, you can call Honda Automobile Customer Service (see also page 164).

**Call (800) 999-1009 (U.S.) or (888) 946-6329 (Canada)**

## Honda Roadside Assistance

24-hour emergency road service is available to you in the United States and Canada throughout your 3-year/36,000-mile warranty term. Services include jump starting, flat tire and lockout assistance, towing, and more (limitations apply).

**Call (866) 864-5211 (U.S.) or (800) 465-7587 (Canada)**

# TABLE OF CONTENTS

DISCLOSURES .....	C2	AUDIO AND CONNECTIVITY .....	62
INTRODUCTION .....	C4	Basic Audio Operation .....	62
Honda Automobile Customer Service .....	C4	Models with Color Audio System .....	66
Honda Roadside Assistance .....	C4	Color Audio System .....	66
TABLE OF CONTENTS .....	C5	FM/AM Radio .....	67
VISUAL INDEX .....	1	iPod® .....	68
Steering Wheel and Nearby Controls .....	1	USB Flash Drive .....	69
Dashboard Controls .....	2	Pandora® .....	70
SAFETY INFORMATION .....	3	Bluetooth® Audio .....	71
Important Safety Information .....	3	Display Audio Operation .....	72
Seat Belts .....	5	HondaLink® .....	73
Airbags .....	9	HondaLink® Assist .....	74
Child Safety .....	15	Wi-Fi Connection .....	74
Safety Label Locations .....	22	Apple CarPlay™ .....	75
Reporting Safety Defects .....	23	Android Auto™ .....	76
INSTRUMENT PANEL .....	24	FM/AM Radio .....	77
Malfunction Indicators .....	24	SiriusXM® Radio* .....	78
Condition Indicators .....	26	iPod® .....	79
On/Off Indicators .....	27	USB Flash Drive .....	80
Information Display* .....	28	Bluetooth® Audio .....	81
Driver information interface (DII)* .....	29	Pandora®* .....	82
Customized Features .....	32	BLUETOOTH HANDSFREELINK® (HFL) .....	83
VEHICLE CONTROLS .....	34	Models with color audio system .....	83
Using the Key or Remote Transmitter .....	34	Basic HFL Operation .....	83
Smart Entry System* .....	35	Pairing a Phone .....	84
Door Operation .....	38	Making a Call .....	85
Tailgate Operation* .....	39	Models with Display Audio .....	86
Power Tailgate Operation* .....	39	Basic HFL Operation .....	86
Rear Cargo Cover* .....	40	Pairing a Phone .....	88
Power Window Operation .....	41	Making a Call .....	89
Power Moonroof Operation* .....	42	SMS Text Messaging and E-Mail* .....	91
Panoramic Glass Roof* .....	43	Siri® Eyes Free .....	92
Center Console Box .....	44	NAVIGATION* .....	93
Interior and Exterior Lights .....	45	Basic Navigation Operation .....	93
One-Touch Turn Signal .....	46	Entering a Destination .....	95
Auto High-Beam System* .....	47	Routing .....	98
Wiper Operation .....	49		
Adjusting the Seats .....	51		
Rear Seats .....	54		
Under-Floor Storage Area .....	55		
Driving Position Memory System* .....	56		
Adjusting the Steering Wheel .....	56		
Adjusting the Mirrors .....	57		
HomeLink® Universal Transceiver* .....	58		
Climate Control System .....	59		
Seat Heaters* .....	60		
Setting the Clock .....	61		

**DRIVING**.....100  
 Before Driving.....100  
 Maximum Load Limit.....102  
 Improving Fuel Economy and  
 Reducing CO<sub>2</sub> Emissions .....103  
 Towing Your Vehicle.....103  
 Towing a Trailer .....104  
 Remote Engine Start with  
 Vehicle Feedback\* .....105  
 Starting to Drive.....106  
 Braking.....107  
 Vehicle Stability Assist (VSA®) .....110  
 Eco Assist™ System .....110  
 Cruise Control\* .....111  
 Honda Sensing™\* .....112  
 Adaptive Cruise Control (ACC)  
 with Low Speed Follow (LSF)\* .....113  
 Lane Keeping Assist System (LKAS)\* .....117  
 Road Departure Mitigation (RDM)\* .....118  
 Collision Mitigation Braking System™  
 (CMBS™)\* .....119  
 LaneWatch™\* .....121  
 Multi-View Rear Camera.....122  
 Blind Spot Information (BSI)\* .....124  
 Refueling.....125

**HANDLING THE UNEXPECTED**.....126  
 Smart Entry Remote Battery Strength\* .....126  
 Shift Lever Does Not Move.....126  
 Jump Starting.....127  
 Overheating.....129  
 Refueling from a Portable Fuel Container .....130  
 Emergency Engine Stop\* .....131  
 Emergency Towing.....131  
 Tire Pressure Monitoring System (TPMS) .....132  
 Changing a Flat Tire .....134  
 Fuse Locations.....137

**MAINTENANCE**.....140  
 Safety Precautions.....140

Maintenance Minder™ .....141  
 Under the Hood.....144  
 Turbocharger\* Precautions.....146  
 Engine Oil.....146  
 Engine Coolant.....149  
 Checking the Battery.....151  
 Brake Fluid.....151  
 Window Washer Fluid .....151  
 Changing Wiper Blades .....152  
 Tire Information .....154  
 Tire Labeling.....157  
 DOT Tire Quality Grading.....159  
 Air Conditioning Maintenance .....160  
 Testing of Readiness Codes .....161

**SPECIFICATIONS**.....162

**CUSTOMER INFORMATION** .....163

Frequently Asked  
 Questions/Troubleshooting.....163  
 Contact Us.....164  
 Honda Roadside Assistance .....165  
 Warranty Coverages.....165  
 EPA Contact Information.....165

**VOICE COMMAND INDEX**.....166

**INDEX**.....168

**DISCLOSURES** .....173

# VISUAL INDEX

Quickly locate items in the vehicle's interior.

## Steering Wheel and Nearby Controls

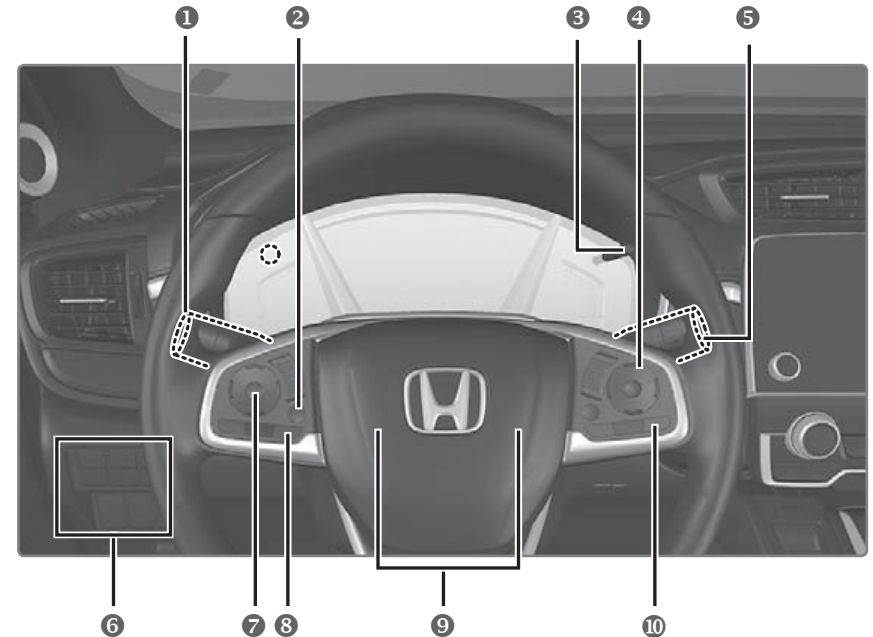

- 1 Headlights/turn signals p. 46  
 Fog lights\* p. 46  
 LaneWatch\* p. 121
- 2 (Display/Information) button\* p. 29
- 3 Brightness control p. 45
- 4 Cruise control buttons\* p. 111  
 Adaptive cruise control (ACC) with  
 Low Speed Follow (LSF) buttons\* p. 113
- 5 Wipers/washers p. 49
- 6 TPMS button p. 132  
 VSA OFF button p. 110  
 RDM button\* p. 118  
 CMBS button\* p. 119  
 Heated windshield button\* p. 60  
 Power tailgate button\* p. 39
- 7 Audio controls p. 64
- 8 Voice recognition buttons p. 83,  
 p. 87
- 9 Horn
- 10 Lane Keeping Assist System (LKAS)  
 button\* p. 117

\*if equipped

\*if equipped



## Dashboard Controls

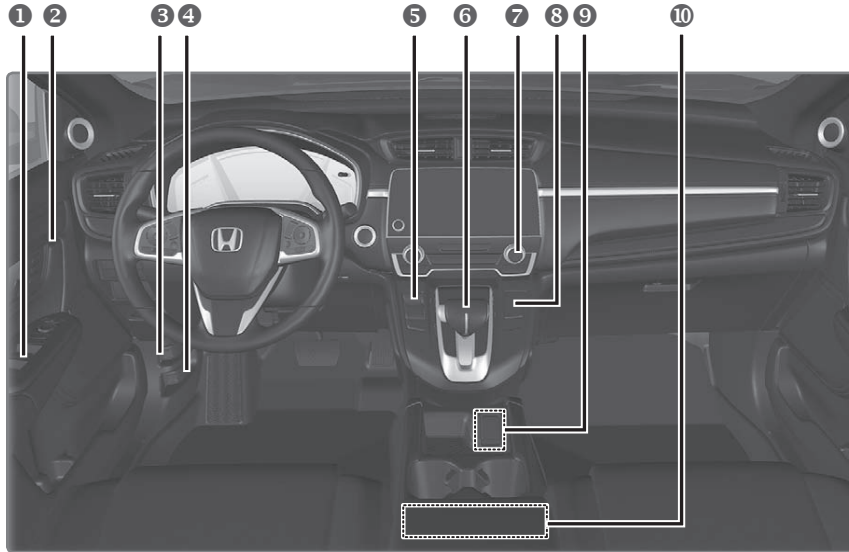

- |  |  |
|--|--|
| <p>① Power window switches p. 41<br/>Door mirror controls p. 57<br/>Door lock switches p. 38</p> <p>② Memory/SET buttons* p. 56</p> <p>③ Hood release handle p. 110</p> <p>④ Fuel fill door release handle p. 125</p> <p>⑤ Electric parking brake switch p. 108<br/>Automatic Brake Hold button p. 109</p> | <p>⑥ Shift lever p. 107</p> <p>⑦ Climate control p. 59</p> <p>⑧ ECON button p. 110</p> <p>⑨ Accessory power socket p. 62</p> <p>⑩ USB port(s) p. 62<br/>Accessory power socket p. 62</p> |
|--|--|

## SAFETY INFORMATION

Your safety—and the safety of others—is very important, and operating this vehicle safely is an important responsibility. While we strive to help you make informed decisions about safety, it is not practical or possible to warn you about all the hazards associated with operating or maintaining your vehicle. Therefore, you must use your own good judgment.

### Important Safety Information

This guide explains many of your vehicle's safety features and how to use them. Please read this information carefully. Following the instructions below will also help to keep you and your passengers safe.

#### ■ Important Safety Precautions

- Always wear your seat belt.
- Secure all children in the proper restraint system.
- Be aware of airbag hazards.
- Don't drink and drive.
- Pay appropriate attention to the task of driving safely.
- Control your speed.
- Keep your vehicle in safe condition.
- Do not leave children unattended in the vehicle.

Engaging in cell phone conversation or other activities that keep you from paying close attention to the road, other vehicles, and pedestrians could lead to a crash. Remember, situations can change quickly, and only you can decide when it is safe to divert some attention away from driving.

#### ■ Safety Messages

When you see the following messages throughout this guide, pay close attention.

**⚠ DANGER** You **WILL** be **KILLED** or **SERIOUSLY HURT** if you don't follow instructions.

**⚠ WARNING** You **CAN** be **KILLED** or **SERIOUSLY HURT** if you don't follow instructions.

**⚠ CAUTION** You **CAN** be **HURT** if you don't follow instructions.

**NOTICE** This information is intended to help you avoid damage to your vehicle, other property, or the environment.

*\*if equipped*

### ■ Important Handling Information

Your vehicle has higher ground clearance than a passenger vehicle designed for use only on pavement. Higher ground clearance has many advantages for off-highway driving. It allows you to travel over bumps, obstacles, and rough terrain. It also provides good visibility so you can anticipate problems earlier.

These advantages come at some cost. Because your vehicle is taller and rides higher off the ground, it has a higher center gravity making it more susceptible to tripping or rollover if you make abrupt turns. Utility vehicles have a significantly higher rollover rate than other types of vehicles. In a rollover crash, an unbelted person is significantly more likely to die than a person wearing a seat belt. As a reminder, make sure you and your passengers always wear seat belts.

### ■ Carbon Monoxide Gas

The engine exhaust from this vehicle contains carbon monoxide, a colorless, odorless, and highly toxic gas. As long as you properly maintain your vehicle and follow the instructions set forth below, you will not accumulate dangerous levels of carbon monoxide gas in the vehicle interior.

Have the exhaust system inspected for leaks whenever:

- The exhaust system is making an unusual noise.
- The exhaust system may have been damaged.
- The vehicle is raised for an oil change.

When you operate a vehicle with the tailgate open, airflow can pull exhaust gas into the interior and create a hazardous condition. If you must drive with the tailgate open, open all the windows and set the climate control system as shown below.

1. Select the fresh air mode.
2. Select the  mode.
3. Set the fan speed to high.
4. Set the temperature control to a comfortable setting.

Adjust the climate control system in the same manner if you sit in your parked vehicle with the engine running.

#### **WARNING**

Carbon monoxide gas is toxic. Breathing it can cause unconsciousness and even kill you.

Avoid any enclosed areas or activities that expose you to carbon monoxide.

An enclosed area such as a garage can quickly fill up with carbon monoxide gas. Do not run the engine with the garage door closed. Even when the garage door is open, drive out of the garage immediately after starting the engine.

### Seat Belts

A seat belt is your best protection in all types of collisions. Airbags are designed to supplement seat belts, not replace them. So even though your vehicle is equipped with airbags, make sure you and your passengers always wear your seat belts and wear them properly.

#### ■ Lap/Shoulder Seat Belts

All five seating positions are equipped with lap/shoulder seat belts with emergency locking retractors. In normal driving, the retractor lets you move freely while keeping some tension on the belt. During a collision or sudden stop, the retractor locks to restrain your body. The rear seat belts also have a lockable retractor for use with child seats.

The front seats are equipped with automatic seat belt tensioners to enhance safety. The tensioners automatically tighten the front seat belts during a moderate to severe frontal collision, sometimes even if the collision is not severe enough to inflate the front airbags.

#### ■ Proper Use of Seat Belts

Follow these guidelines for proper use:

- All occupants should sit upright, well back in the seat, and remain in that position for the duration of the trip. Slouching and leaning reduce the effectiveness of the belt and can increase the chance of serious injury in a crash.
- Never place the shoulder part of a lap/shoulder seat belt under your arm or behind your back. This could cause very serious injuries in a crash.
- Two people should never use the same seat belt. If they do, they could be very seriously injured in a crash.
- Do not put any accessories on the seat belts. Devices intended to improve comfort or reposition the shoulder part of a seat belt can reduce the protective capability and increase the chance of serious injury in a crash.
- No one should sit in a seat with an inoperative seat belt or one that does not appear to be working correctly. Using a seat belt that is not working properly may not protect the occupant in a crash. Have a dealer check the belt as soon as possible.

#### **WARNING**

Not wearing a seat belt properly increases the chance of a serious injury or death in a crash, even though your vehicle has airbags.

Be sure you and your passengers always wear seat belts and wear them properly.

### ■ Seat Belt Inspection

Regularly check the condition of your seat belts as follows:

- Pull each belt out fully, and look for frays, cuts, burns, and wear.
- Check that the latch plates and buckles work smoothly and the belts retract easily. If a belt does not retract easily, cleaning the belt may correct the problem. Use only mild soap and warm water. Do not use bleach or cleaning solvents. Make sure the belt is completely dry before allowing it to retract.

Any belt that is not in good condition or working properly will not provide proper protection and should be replaced as soon as possible.

A belt that has been worn during a crash may not provide the same level of protection in a subsequent crash. Have your seat belts inspected by a dealer after any collision.

#### **WARNING**

Not checking or maintaining seat belts can result in serious injury or death if the seat belts do not work properly when needed.

Check your seat belts regularly and have any problem corrected as soon as possible.

### ■ Fastening a Seat Belt

Adjust your seat to the proper position (see page 51), and then follow the steps below.

1. Pull the seat belt out slowly.
2. Insert the latch plate into the buckle, then tug on the belt to make sure the buckle is secure. Make sure that the belt is not twisted or caught on anything.
3. Position the lap part of the belt as low as possible across your hips, then pull up on the shoulder part of the belt so the lap part fits snugly. This lets your strong pelvic bones take the force of a crash and reduces the chance of internal injuries.
4. If necessary, pull up on the belt again to remove any slack, then make sure that the belt rests across the center of your chest and over your shoulder. This spreads the forces of a crash over the strongest bones in your upper body.

To release the belt, push the red PRESS button then guide the belt by hand until it has retracted completely.

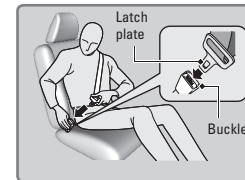

#### **WARNING**

Improperly positioning the seat belts can cause serious injury or death in a crash.

Make sure all seat belts are properly positioned before driving.

### ■ Adjusting the Shoulder Anchor

The front seats have adjustable shoulder anchors to accommodate taller and shorter occupants.

1. Move the anchor up and down while holding the release buttons.
2. Position the anchor so that the belt rests across the center of your chest and over your shoulder.

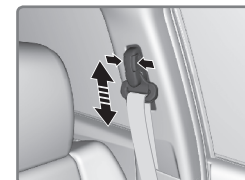

## ■ Seat Belt with Detachable Anchor

The seat belt for the rear center seat is located in the ceiling.

1. Pull out the seat belt's small latch plate and the latch plate from each holding slot in the ceiling.
2. Line up the triangle marks on the small latch plate and anchor buckle. Make sure the seat belt is not twisted. Attach the belt to the anchor buckle.
3. Insert the latch plate into the buckle. Properly fasten the seat belt the same way you fasten the lap/shoulder seat belt.

To unlatch the detachable anchor, insert the latch plate into the slot on the side of the anchor buckle.

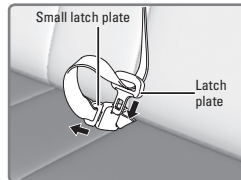
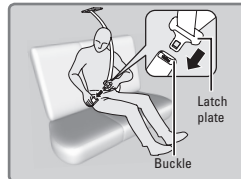
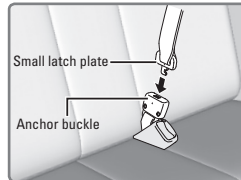
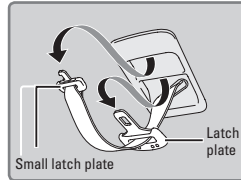

### ⚠️ WARNING

Using the seat belt with the detachable anchor unlatched increases the chance of serious injury or death in a crash.

Before using the seat belt, make sure the detachable anchor is correctly latched.

## Airbags

Your vehicle is equipped with three types of airbags: front airbags, side airbags, and side curtain airbags.

### ■ Front Airbags (SRS)

The front SRS airbags inflate in a moderate-to-severe frontal collision to help protect the head and chest of the driver and/or front passenger. They are housed in the center of the steering wheel for the driver, and in the dashboard for the front passenger. Both airbags are marked **SRS AIRBAG**.

SRS (Supplemental Restraint System) indicates that the airbags are designed to supplement seat belts, not replace them. Seat belts are the occupant's primary restraint system.

Your front airbags have advanced features to help reduce the likelihood of airbag-related injuries to smaller occupants.

### ■ Advanced Airbags

The driver's advanced front airbag system includes a seat position sensor. Based on information from this sensor and the severity of the impact, the advanced airbag system determines the optimal deployment of the driver's airbag.

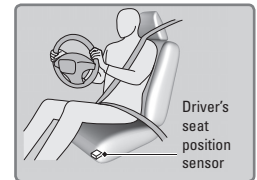

The passenger's front airbag system has weight sensors.

We advise against allowing a child age 12 or under to ride in the front passenger's seat. However, if you do allow a child age 12 or under to ride in the front passenger's seat, note that the system will automatically turn off the front passenger's airbag if the sensors detect that the child is approximately 65 lbs (29kg) or less.

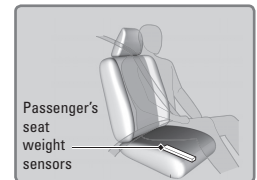

For the airbags to work properly:

- Do not spill any liquid on or under the seats.
- Do not put any object under the passenger's seat.
- Make sure any objects are positioned properly on the floor. Improperly positioned objects can interfere with the advanced airbag sensors.
- All occupants should sit upright and wear their seat belts properly.
- Do not cover the passenger's side dashboard with a cloth, towel, cover, etc.
- Make sure the floor mat behind the front passenger's seat is hooked to the floor mat anchor. An improperly placed mat can interfere with the airbag sensors.

## ■ Side Airbags

The side airbags help protect the upper torso and pelvis of the driver or a front passenger during a moderate-to-severe side impact. They are housed in the outside edge of the driver's and front passenger's seat-backs. Both are marked **SIDE AIRBAG**.

## ■ Side Curtain Airbags

Side curtain airbags help protect the head of the driver and passengers in outer seating positions during a moderate-to-severe side impact. The side curtain airbags equipped in this vehicle are also designed to help reduce the likelihood of partial and complete ejection of vehicle occupants through side windows in crashes, particularly rollover crashes.

The side curtain airbags are located in the ceiling above the side windows on both sides of the vehicle.

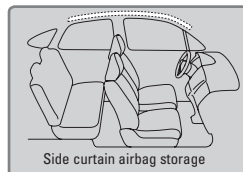

The side curtain airbags are designed to deploy in a rollover or moderate-to-severe side impact. If the SRS control unit senses that your vehicle is about to roll over, it immediately deploys both side curtain airbags and activates both front seat belt tensioners. If the impact is on the passenger's side, the passenger's side curtain airbag will inflate even if there are no occupants on that side of the vehicle.

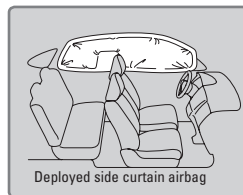

To get the best protection from the side curtain airbags, occupants should wear their seat belts properly and sit upright and well back in their seats.

Do not attach any objects to the side windows or roof pillars, as they can interfere with the proper operation of the side curtain airbags.

### When side curtain airbags deploy in a frontal collision

One or both side curtain airbags may inflate in a moderate-to-severe angled frontal collision.

## ■ Important Facts About Your Airbags

Always wear your seat belt properly, and sit upright and as far back from the steering wheel as possible while allowing full control of the vehicle. A front passenger should move their seat as far back from the dashboard as possible.

**Do not place hard or sharp objects between yourself and a front airbag.** Carrying hard or sharp objects on your lap, or driving with a pipe or other sharp object in your mouth, can result in injuries if your front airbag inflates.

**Do not attach or place objects on the front airbag covers.** Objects on the covers marked **SRS AIRBAG** could interfere with the proper operation of the airbags or be propelled inside the vehicle and hurt someone if the airbags inflate.

**Do not attach accessories on or near the side airbags.** They can interfere with the proper operation of the airbags, or hurt someone if an airbag inflates.

**Do not attach any objects to the side windows or roof pillars.** They can interfere with the proper operation of the side curtain airbags.

**Do not cover or replace the front seat-back covers.** This can prevent your side airbags from properly deploying during a side impact.

### ⚠ WARNING

An open glove box can cause serious injury to your passenger in a crash, even if the passenger is wearing the seat belt.

Always keep the glove box closed while driving.

## ■ Airbag System Indicators

If a problem occurs in the airbag system, the SRS indicator comes on and a message appears on the driver information interface\*.

### SRS (Supplemental Restraint System) indicator

If the indicator comes on at any other time besides vehicle start-up, or does not come on at all, have the system checked by a dealer as soon as possible. If you don't, your airbags and seat belt tensioners may not work properly when they are needed.



### ⚠ WARNING

Ignoring the SRS indicator can result in serious injury or death if the airbag systems or tensioners do not work properly.

Have your vehicle checked by a dealer as soon as possible if the SRS indicator alerts you to a possible problem.

### Passenger Airbag Off indicator

The indicator comes on to alert you that the front passenger's front airbag has been turned off. This occurs when the front passenger's weight sensors detect about 65 lbs (29 kg) or less, the weight of an infant or small child, on the seat.

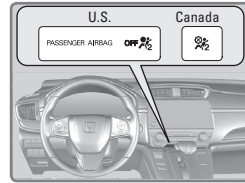

Children age 12 or under should always ride properly restrained in a back seat.

If the front passenger's seat is empty, the passenger's front airbag will not deploy and the indicator will come on.

To ensure the passenger is detected properly, check that:

- There is no child seat or other object pressing against the rear of the seat-back.
- There is no rear passenger pushing or pulling on the back of the front passenger's seat.
- The front seat or seat-back is not forced back against an object on the seat or floor behind it.
- There is no object placed under or beside the front passenger's seat.
- The occupant is sitting in an upright position and the seat back is not excessively reclined.
- The occupant is not leaning against the door or center console.
- The occupant's feet are placed on the floor in front of them.
- There are no objects hanging from the front passenger's seat.
- Only small, lightweight objects are in the seat-back pocket.

The passenger airbag off indicator may come on and go off repeatedly if the total weight on the seat is near the airbag cutoff threshold.

Have your vehicle checked by a dealer as soon as possible if:

- All of the above conditions exist, and the indicator comes on with an adult riding there.
- The seat is empty and the indicator is off.

Do not allow an adult passenger to ride in the front seat when the indicator is on.

### Airbag System Components

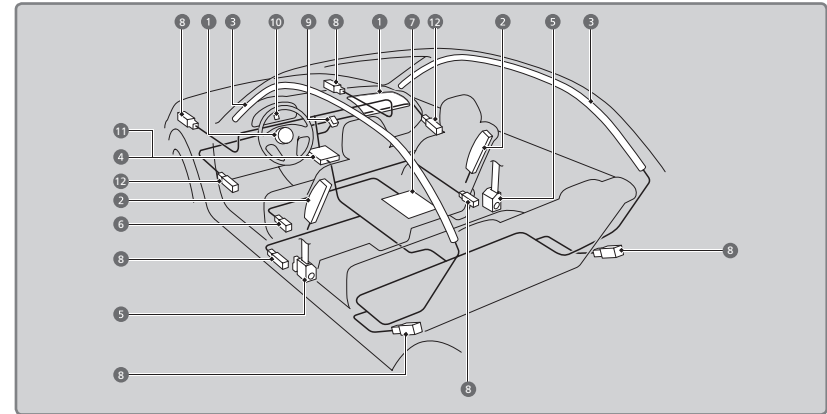

1. Two SRS (Supplemental Restraint System) front airbags. The driver's airbag is stored in the center of the steering wheel; the front passenger's airbag is stored in the dashboard. Both are marked **SRS AIRBAG**.
2. Two side airbags, one for the driver and one for a front passenger. The airbags are stored in the outer edges of the seatbacks. Both are marked **SIDE AIRBAG**.
3. Two side curtain airbags, one for each side of the vehicle. The airbags are stored in the ceiling, above the side windows. The front and rear pillars are marked **SIDE CURTAIN AIRBAG**.
4. An electronic control unit that, when the vehicle is on, continually monitors information about the various impact sensors, seat and buckle sensors, airbag activators, seat position sensor, seat weight sensor, passenger front airbag off indicator, and seat belt tensioners. During a crash event the unit records such information.
5. Automatic front seat belt tensioners. In addition, the driver's and front passenger's seat belt buckles incorporate sensors that detect whether or not the belts are fastened.
6. A driver's seat position sensor. This sensor determines the optimal force at which the airbag will deploy in a crash.
7. Weight sensors in the front passenger's seat. The front passenger's airbag will be turned off if the weight on the seat is approximately 65 lbs (29 kg) or less (the weight of an infant or small child).
8. Impact sensors that can detect a moderate-to-severe front or side impact.
9. An indicator on the dashboard that alerts you that the front passenger's front airbag has been turned off.



10. An indicator on the instrument panel that alerts you to a possible problem with your airbag system or seat belt tensioners.
11. A rollover sensor that can detect if your vehicle is about to roll over and signal the control unit to deploy both side curtain airbags.
12. Pressure sensors inside each front door that control side airbag deployment.

#### ■ Airbag Care

You do not need to, and should not, perform any maintenance on or replace any airbag system components yourself. However, you should have your vehicle inspected by a dealer in the following situations:

##### When the airbags have deployed

If an airbag has inflated, the control unit and other related parts must be replaced. Similarly, once an automatic seat belt tensioner has been activated, it must be replaced.

##### When the vehicle has been in a moderate-to-severe collision

Even if the airbags did not inflate, have your dealer inspect the following: the driver's seat position sensor, weight sensors in the passenger's seat, front seat belt tensioners, and each seat belt that was worn during the crash.

##### Do not remove or modify a front seat without first consulting a dealer

This would likely disable the driver's seat position sensor or the weight sensors in the passenger's seat. If it is necessary to remove or modify a front seat to accommodate a person with disabilities, contact a Honda dealer. For U.S. vehicles, call Honda Automobile Customer Service at (800) 999-1009. For Canadian vehicles, call Honda Canada Customer Relations at (888) 946-6329.

## Child Safety

Each year, many children are injured or killed in vehicle crashes because they are either unrestrained or not properly restrained. In fact, vehicle collisions are the number one cause of death of children ages 12 and under.

The National Highway Traffic Safety Administration and Transport Canada recommend that all children ages 12 and under be properly restrained in a rear seat. Some states or provinces/territories have laws restricting where children may ride.

To reduce the number of child deaths and injuries, every state, Canadian province and territory requires that infants and children be properly restrained when they ride in a vehicle.

#### ■ Protecting Child Passengers

- An inflating front or side airbag can injure or kill a child sitting in the front seat.
- A child in the front seat is more likely to interfere with the driver's ability to safely control the vehicle.
- Statistics show that children of all sizes and ages are safer when they are properly restrained in a rear seat.
- Any child who is too small to wear a seat belt correctly must be restrained in an approved child seat that is properly secured to the vehicle using either the lap belt portion of the lap/shoulder belt or the lower anchors of the LATCH system.
- Never put a seat belt over yourself and a child. During a crash, the belt would likely press deep into the child and cause serious or fatal injuries.
- Never let two children use the same seat belt. Both children could be very seriously injured in a crash.
- Do not allow children to operate the doors, windows, or seat adjusters.
- Do not leave children in the vehicle unattended, especially in hot weather when the inside of the vehicle can get hot enough to kill them. They could also activate vehicle controls, causing it to move unexpectedly.

### WARNING

Children who are unrestrained or improperly restrained can be seriously injured or killed in a crash.

Any child too small for a seat belt should be properly restrained in a child seat. A larger child should be properly restrained with a seat belt, using a booster seat if necessary.



**⚠️ WARNING**

Allowing a child to play with a seat belt or wrap one around their neck can result in serious injury or death.

Instruct children not to play with any seat belt and make sure any unused seat belt a child can reach is buckled, fully retracted, and locked.

**■ Protecting Infants**

An infant must be properly restrained in a rear-facing, reclining child seat until the infant reaches the seat maker's weight or height limit for the seat, and the infant is at least one year old. Many experts recommend use of a rear-facing seat for a child up to two years old if the child's height and weight are appropriate for a rear-facing seat.

Child seats must be placed and secured in a rear seating position. Rear-facing child seats should never be installed in a forward-facing position.

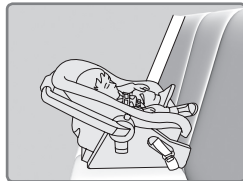

When properly installed, a rear-facing child seat may prevent the driver or a front passenger from moving their seat all the way back or from locking their seat-back in the desired position. Make sure that there is no contact between the child seat and the seat in front of it. It can also interfere with proper operation of the front passenger's advanced front airbag system. If this occurs, we recommend that you install the child seat directly behind the front passenger's seat, move the seat as far forward as needed and leave it unoccupied. Or you may wish to get a smaller rear-facing child seat.

**⚠️ WARNING**

Placing a rear-facing child seat in the front seat can result in serious injury or death during a crash.

Always place a rear-facing child seat in the rear seat, not the front.

**■ Protecting Smaller Children**

If a child is at least one year old and within the weight range indicated by the child seat manufacturer, the child should be properly restrained in a firmly secured forward-facing child seat.

We strongly recommend placing a forward-facing child seat in a rear seating position.

Placing a forward-facing child seat in the front seat can be hazardous, even with advanced front airbags that automatically turn the passenger's front airbag off. A rear seat is the safest place for a child.

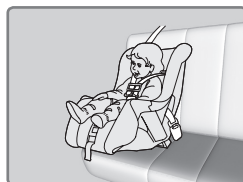
**⚠️ WARNING**

Placing a forward-facing child seat in the front seat can result in serious injury or death if the front airbag inflates.

If you must place a forward-facing child seat in front, move the vehicle seat as far back as possible, and properly restrain the child.

**■ Selecting a Child Seat**

Most child seats are LATCH-compatible (Lower Anchors and Tethers for CHildren). Some have a rigid-type connector, while others have a flexible-type connector. Both are equally easy to use. Some existing and previously owned child seats can only be installed using the seat belt. Whichever type you choose, follow the child seat manufacturer's use and care instructions as well as the instructions in this manual. Proper installation is key to maximizing your child's safety.

In seating positions and vehicles not equipped with LATCH, a LATCH-compatible child seat can be installed using the seat belt and a top tether for added security. This is because all child seats are required to be designed so that they can be secured with a lap belt or the lap part of a lap/shoulder belt. In addition, the child seat manufacturer may advise that a seat belt be used to attach a LATCH-compatible seat once a child reaches a specified weight. Please read the child seat owner's manual for proper installation instructions.

**Important considerations when selecting a child seat**

- Make sure the child seat meets the following three requirements:
- The child seat is the correct type and size for the child.
- The child seat is the correct type for the seating position.
- The child seat is compliant with Federal Motor Vehicle Safety Standard 213 or Canadian Motor Vehicle Safety Standard 213.

**⚠️ WARNING**

Children who are unrestrained or improperly restrained can be seriously injured or killed in a crash.

Any child too small for a seat belt should be properly restrained in a child seat. A larger child should be properly restrained with a seat belt, using a booster seat if necessary.

### ■ Installing a LATCH-Compatible Child Seat

A LATCH-compatible child seat can be installed in either of the two outer rear seats. A child seat is attached to the lower anchors with either the rigid or flexible type of connectors.

1. Locate the lower anchors under the marks.

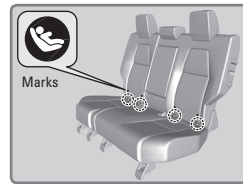

2. Place the child seat on the vehicle seat, then attach the child seat to the lower anchors according to the instructions that came with the child seat. Make sure that the lower anchors are not obstructed by the seat belt or any other object. Put the head restraint in its highest position.

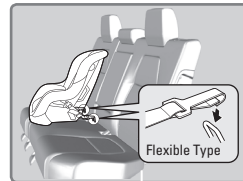
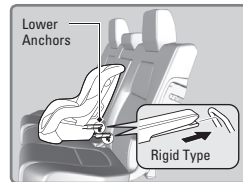

3. **For outer seats:** Route the tether strap between the head restraint legs.

**For the center seat:** Open the anchor cover. Route the tether strap through the head restraint legs.

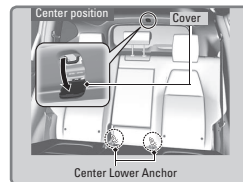
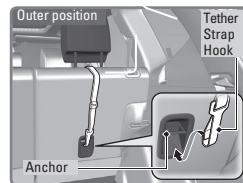

4. Secure the tether strap hook onto the anchor and tighten as instructed by the manufacturer. Make sure the strap is not twisted. Make sure any unused seat belt that a child can reach is buckled, the lockable retractor is activated, and the belt is fully retracted and locked.

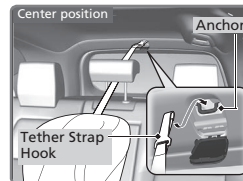

### ■ Installing a Child Seat with a Lap/Shoulder Seat Belt

A child seat can be installed with a lap/shoulder belt in any rear seat or, if absolutely necessary, the front passenger seat.

1. Place the child seat on the vehicle seat.
2. Route the seat belt through the child seat according to the seat maker's instructions, and insert the latch plate into the buckle. Insert the latch plate fully until it clicks.
3. Slowly pull the shoulder part of the belt all the way out until it stops. This activates the lockable retractor.
4. Let the seat belt completely wind up into the retractor, then try to pull it out to make sure the retractor is locked. If you are able to pull the shoulder belt out, the lockable retractor is not activated. Pull the seat belt all the way out, and repeat steps 3 – 4.
5. Grab the shoulder part of the seat belt near the buckle, and pull up to remove any slack from the lap part of the belt. When doing this, place your weight on the child seat and push it into the vehicle seat.
6. Make sure the child seat is firmly secured by rocking it forward and back and side to side; less than one inch of movement should occur near the seat belt.
7. Make sure any unused seat belt that a child can reach is buckled, the lockable retractor is activated, and the belt is fully retracted and locked.

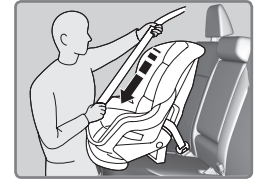
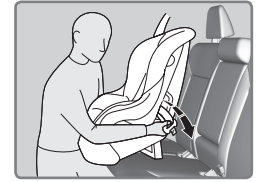

To deactivate a lockable retractor, release the buckle and allow the seat belt to wind up all the way.

### ■ Adding Security with a Tether

Two tether anchorage points are provided behind the rear outer seating positions and one in the ceiling for the rear center. If you have a child restraint system that comes with a tether but can be installed with a seat belt, the tether may be used for additional security.

1. **Using an outer anchor:** Raise the head restraint to its highest position, then route the tether strap through the head restraint legs. Make sure the strap is not twisted.

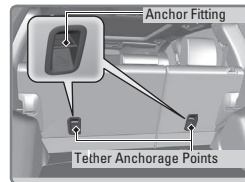

**Using the center anchor:** Raise the head restraint to its highest position, then open the anchor cover.

Make sure the strap is not twisted. Secure the tether strap hook onto the anchor.

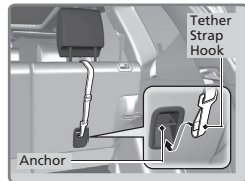

2. Secure the tether strap hook onto the anchor.
3. Route the tether strap through the head restraint legs. Make sure the strap is not twisted.
4. Tighten the tether strap as instructed by the child seat manufacturer.

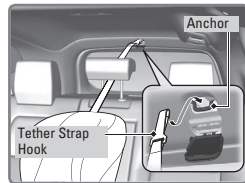

### ■ Protecting Larger Children

When a child is too big for a child seat, secure the child in a rear seat using the lap/shoulder seat belt.

Have the child sit upright and all the way back, then ensure the following:

- The child's knees bend comfortably over the edge of the seat.
- The shoulder belt crosses between the child's neck and arm.
- The lap part of the seat belt is as low as possible, touching the child's thighs.
- The child can stay seated for the whole trip.



If a lap/shoulder belt cannot be used properly, position the child in a booster seat in a rear seating position. For the child's safety, check that the child meets the booster seat manufacturer's recommendations.

Some U.S. states and Canadian provinces/territories require children to use a booster seat until they reach a given age or weight (e.g., 6 years or 60 lbs). Be sure to check current laws in the state or province/territory where you intend to drive.

#### **⚠ WARNING**

Allowing a child age 12 or under to sit in the front can result in injury or death if the passenger's front airbag inflates.

If a larger child must ride in front, move the vehicle seat as far to the rear as possible, then have the child sit up properly and wear the seat belt properly, using a booster seat if needed.

## Safety Label Locations

Safety labels are in the locations shown. They warn you of potential hazards that can cause serious injury or death. Read these labels carefully.

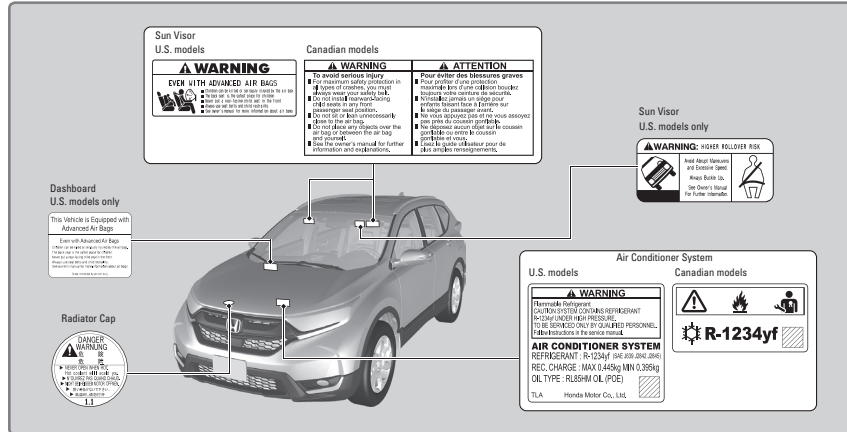

## Reporting Safety Defects

### In the U.S.

If you believe that your vehicle has a defect which could cause a crash or could cause injury or death, you should immediately inform the National Highway Traffic Safety Administration (NHTSA) in addition to notifying American Honda Motor Co., Inc.

If NHTSA receives similar complaints, it may open an investigation, and if it finds that a safety defect exists in a group of vehicles, it may order a recall and remedy campaign. However, NHTSA cannot become involved in individual problems between you, your dealer, or American Honda Motor Co., Inc.

To contact NHTSA, you may call the Vehicle Safety Hotline toll-free at 1-888-327-4236 (TTY: 1-800-424-9153); go to <http://www.safercar.gov>; or write to: Administrator, NHTSA, 1200 New Jersey Avenue, SE., Washington, DC 20590. You can also obtain other information about motor vehicle safety from <http://www.safercar.gov>.

### In Canada

If you believe that your vehicle has a defect which could cause a crash or could cause injury or death, you should immediately inform Honda Canada, Inc., and you may also inform Transport Canada.

If Transport Canada receives similar complaints, it may open an investigation, and if it finds that a safety defect exists in a group of vehicles, it may lead to a recall and remedy campaign. However, Transport Canada cannot become involved in individual problems between you, your dealer, or Honda Canada, Inc.

To contact Transport Canada's Defect Investigations and Recalls Division, you may call 1-800-333-0510. For more information on reporting safety defects or about motor vehicle safety, go to <http://www.tc.gc.ca/roadsafety>.

# INSTRUMENT PANEL

Learn about the indicators, gauges, and displays related to driving the vehicle.

*Not all indicators appear on both types of instrument panels.*

## Models with information display



## Models with Driver Information Interface



Indicators briefly appear with each engine start and then go out. Red and amber indicators are most critical. Blue and green indicators are used for general information.

## Malfunction Indicators

These are the most critical indicators. If they come on and stay lit while driving or at any other time, there may be a problem. See your dealer if necessary.

### **BRAKE** Brake system

U.S.



Canada

- Brake fluid is low.
- The brake system has a problem.

Press the brake pedal lightly to check pedal pressure. If normal, check the brake fluid level when you stop. If abnormal, take immediate action. If necessary, downshift the transmission to slow the vehicle using motor braking. Have your vehicle repaired immediately.



### Low oil pressure

Engine oil pressure is low. Stop in a safe place. Open the hood. Check the oil level, and add oil if necessary (see page 146). If the indicator does not turn off, have your vehicle repaired immediately.



### Charging system

The battery is not charging. Turn off all electrical items, but do not turn off the vehicle to prevent further battery discharge. Have your vehicle repaired immediately.



### Supplemental Restraint System (SRS)

There is a problem with one of the airbag systems or seat belt tensioners.



### Malfunction indicator lamp (check engine light)

The emissions control system may have a problem. Avoid high speeds. Have your vehicle repaired immediately. If the indicator blinks, a misfire in the engine's cylinders is detected. Stop in a safe place and wait for the engine to cool down.



### Anti-lock Brake System (ABS)

There is a problem with the anti-lock brake system. Your vehicle still has normal braking ability, but no anti-lock function.



### Tire Pressure Monitoring System (TPMS)

There is a problem with the tire pressure monitoring system, or the vehicle is fitted with the compact spare tire.



### Collision Mitigation Braking System (CMBS)\*

There is a problem with system, the radar sensor is blocked, or the temperature is too high.



### Lane Departure Warning (LDW)\*

There is a problem with the system, the camera is blocked, or the temperature is too high.



### Lane Keeping Assist System (LKAS)\*

There is a problem with the system, the camera is blocked, or the temperature is too high.



### Vehicle Stability Assist® (VSA)®

There is a problem with the VSA system or hill start assist system.



### Adaptive Cruise Control (ACC) with Low Speed Follow (LSF)\*

The radar sensor is blocked. If the light stays on after you clean the sensor, have the vehicle checked by a dealer. It may also come on while driving in bad weather.



### Electric Power Steering (EPS)

There is a problem with the EPS system. Stop in a safe place and restart the vehicle.

AWD

**All Wheel Drive (AWD)\***

There is a problem with the AWD system. If the indicator blinks, the system is overheating and is inactive. Stop in a safe place and idle until the indicator goes off.

BRAKE  
SYSTEM

U.S.

**Brake system**

There is a problem with one of the braking systems. Your vehicle still has normal braking ability.

**Brake press**

You must press the brake pedal before activating the electric parking brake or automatic brake hold. If the indicator blinks, automatic brake hold is canceled during operation. Immediately press the brake pedal.

**System message**

When a condition or malfunction indicator comes on, a message also appears on the Driver Information Interface. Check the display for more information. Press the display/information button on the steering wheel to clear the message.

**Blind spot information (BSI)\***

There is a problem with the system, or the sensor is blocked.

POWER  
REDUCED**Power Reduced**

There is a problem with the shutter grille. Engine output has been reduced.

**Condition Indicators**

These indicators may require you to perform an action.

BRAKE

U.S.

**Parking brake**

Release the parking brake before driving. You will hear a beep if you drive with it not fully released.

**Seat belt reminder**

Make sure seat belts are fastened for you and all passengers. The indicator blinks and beeps sound continuously if you or your front passenger has not fastened your seat belts when you begin driving. If the indicator remains on after seat belts are fastened, see your dealer.

**Door open**

A door or the tailgate is open.

**Tailgate open**

The tailgate is open.

**Low fuel**

Refuel as soon as possible. If the indicator blinks, there is a problem with the fuel gauge. See your dealer.

**Maintenance Minder**

Scheduled maintenance for your vehicle is due.

**Low tire pressure**

Stop in a safe place, check tire pressures, and inflate tire(s) if necessary. If the indicator remains on after tire inflation, you need to **relearn** the system (see page 132). The indicator also appears if your vehicle is fitted with the compact spare tire. Have your regular tire repaired or replaced as soon as possible.

**Immobilizer**

Your key or remote transmitter cannot be recognized by the vehicle. If the indicator blinks, you may not be able to start the engine. Turn the vehicle off, and then on again. If it continues to blink, there may be a problem with the system. See your dealer.

**Transmission temperature**

The transmission fluid is too hot. Stop in a safe place, shift to Park. The light will turn off when the fluid has cooled.

**On/Off Indicators**

These indicators remind you when an item is on or off.



VSA off



Exterior lights on



VSA engaged (blinking)



ECON mode on



CRUISE MAIN on

LKAS

LKAS\* off



CRUISE CONTROL on



CMBS\* off



Turn signals/ hazards on



Automatic brake hold on



Fog lights\* on



Automatic brake hold activated



Auto High-Beam\* on



High beams on

### Information Display\*

Consists of several displays that provide you with useful information.

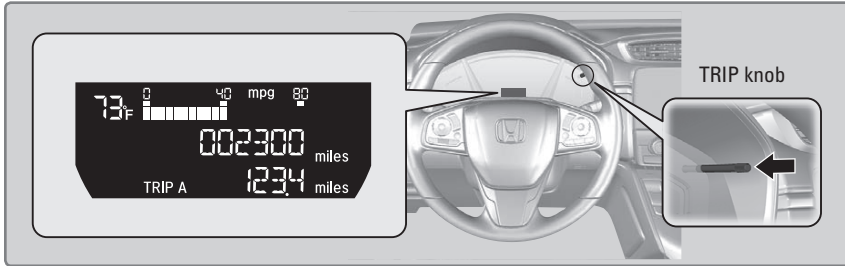

Press the TRIP knob to change displays.

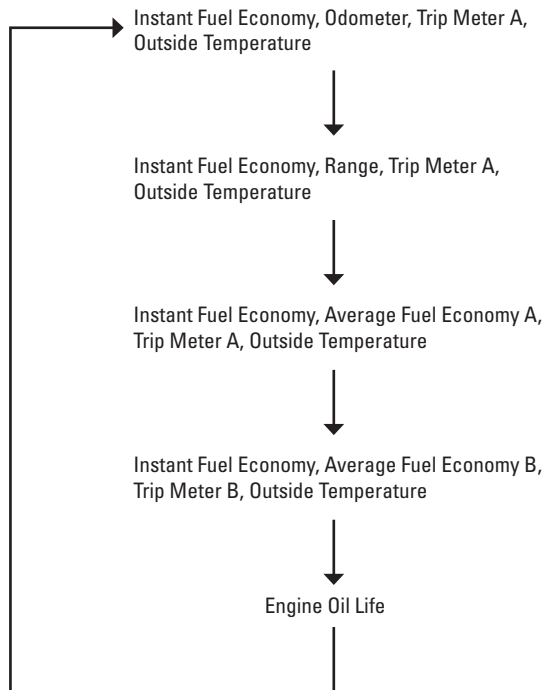

### Driver information interface (DII)\*

Consists of several displays that provide you with useful information.

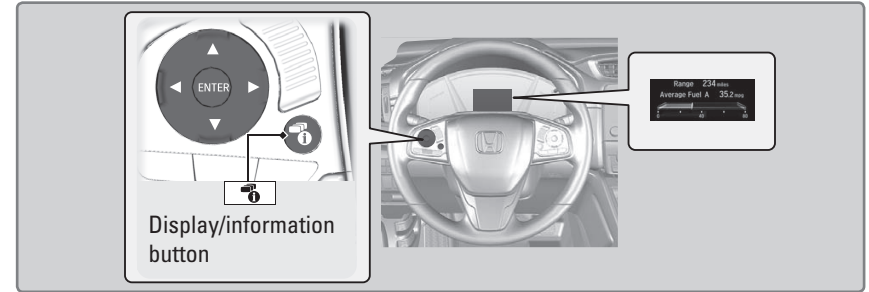

#### Main Displays

Press the display/information and ◀/▶ buttons to change main displays.

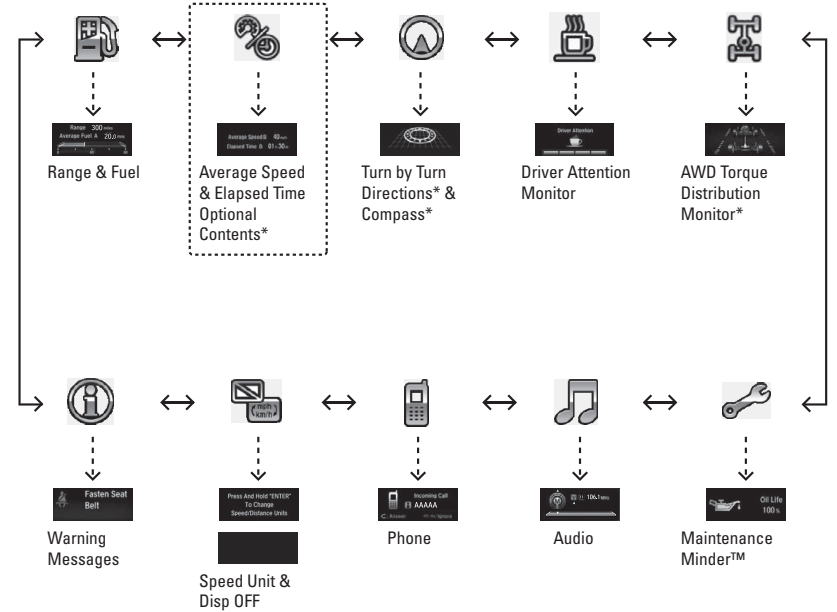

\*if equipped

\*if equipped



### ■ Trip Computer

Use the TRIP knob to change the trip computer displays.

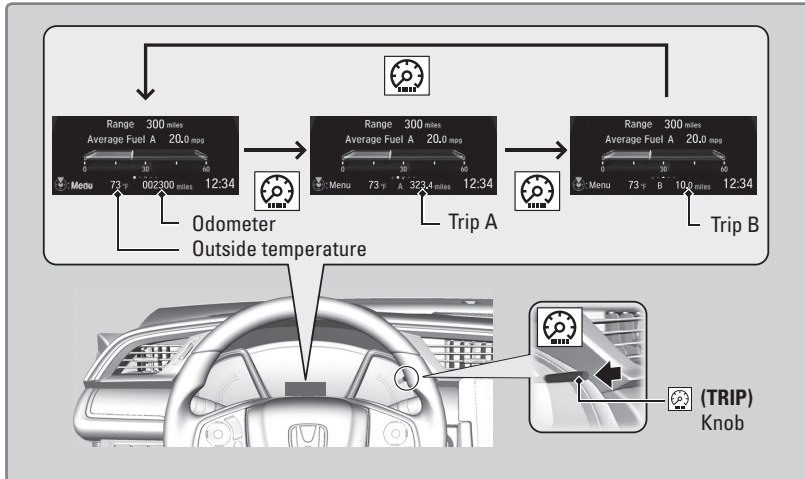

### ■ Driver Attention Monitor

If your driving behavior suggests you are tired, the system alerts you and suggests a break. The system operates at speeds between 25–112 mph (40–180 km/h).

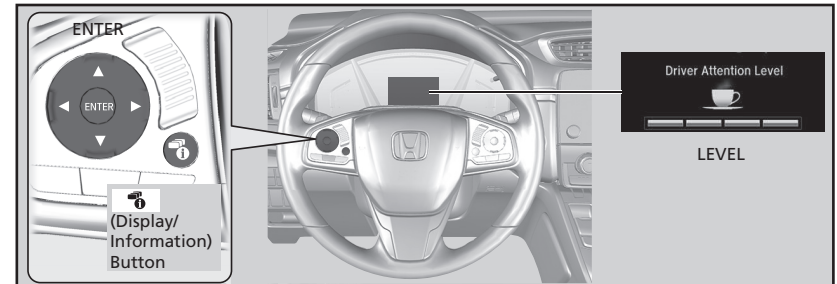

Driver attention is rated on a scale of 1 to 4, 4 being most attentive. If the system detects that attention is down to level 2, it will display a message.

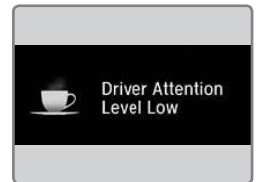

If the system detects that attention is down to level 1, it will beep, vibrate the steering wheel, and suggest a break. Cancel the message by pressing ENTER or by taking more active driving control. If driver attention remains detected at level 1, the message will reappear along with a beep after about 15 minutes.

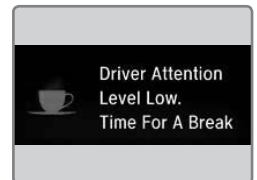

#### To reset the system

- Turn the engine off.
- With the vehicle stopped, unfasten the seat belt and open the door.

#### System limitations

Driver attention monitor does not operate when:

- Travel time is less than 30 minutes.
- LKAS is operating (see page 117).
- Driving on broken or choppy roads.
- It is windy.

## Customized Features

Customize certain features, such as the display, the trip computer, and door locking/unlocking.

### Models with information display

Press MENU/CLOCK, then SETTINGS to make and enter selections when the vehicle is stopped.

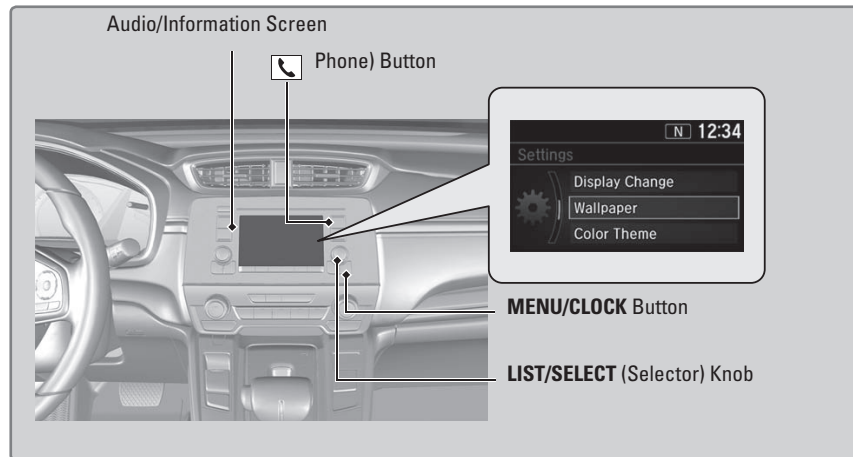

### Models with driver information interface

Press HOME, then SETTINGS to make and enter selections when the vehicle is stopped.

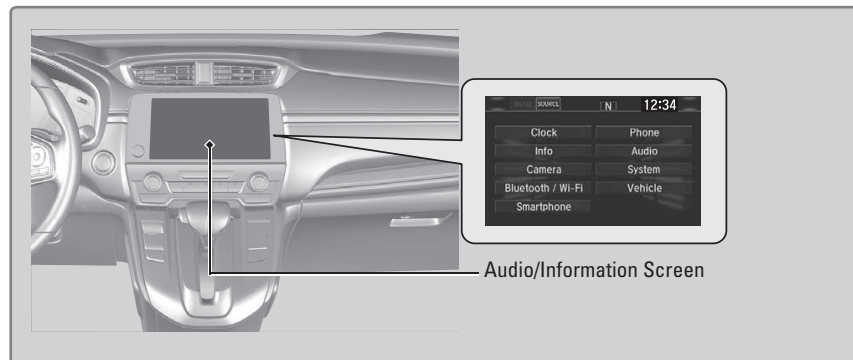

## Customization Example: Door Lock/Unlock Settings

### Models with driver information interface

To customize the door lock/unlock settings, follow the steps below when the vehicle is stopped and the power mode is ON. Use the audio/information screen.

1. Press HOME
2. Press Settings
3. Press Vehicle
4. Press Door/Window Setup
  - To customize door lock settings, press Auto Door Lock
  - To customize door unlock settings, press Auto Door Unlock
5. Choose a setting
  - The default lock setting is Shift from Park
  - The default unlock setting is All Doors when Driver's Door Opens
  - Press the BACK or HOME button when you are done

### Models with information display

See Customizing Door Lock Settings, page 37.

*\*if equipped*

# VEHICLE CONTROLS

Learn about the various controls necessary for operating and driving the vehicle.

## Using the Key or Remote Transmitter

Lock or unlock the doors and tailgate.

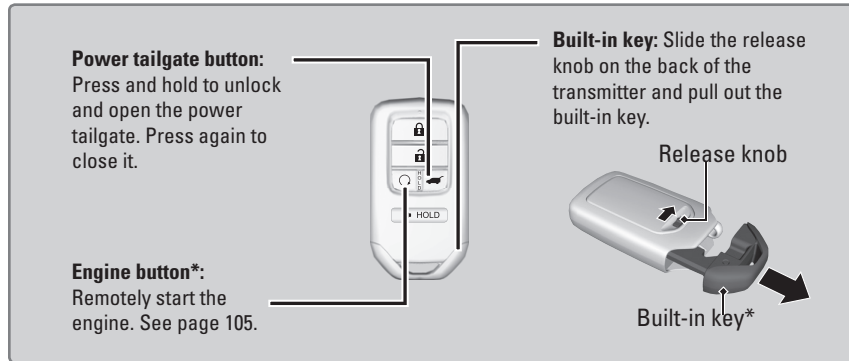
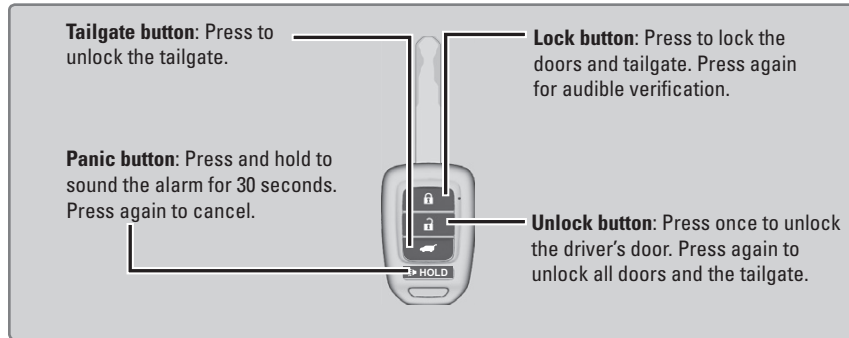

**NOTICE**

Leaving the key or remote transmitter in the vehicle can result in theft or accidental movement of the vehicle. Always take it with you whenever you leave the vehicle unattended.

\*if equipped

## Smart Entry System\*

When you carry the remote transmitter (for example, in a pocket or purse) and it is outside the vehicle and within range (about 32 inches or 80 cm), you can lock or unlock the doors and tailgate without handling the transmitter.

■ **Unlocking/Locking the Doors**

**To unlock:** Grab the driver's door handle when the vehicle is off to unlock the driver's door. Grab the front passenger's door handle to unlock all doors and the tailgate.

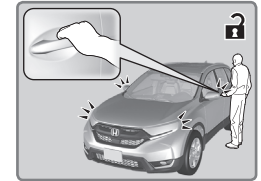

**To lock:** Touch the door lock sensor on the front door handle when the vehicle is off. If the remote transmitter is inside the vehicle, the doors will not lock.

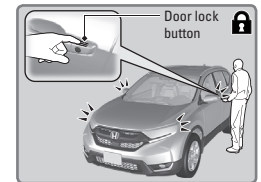

■ **Unlocking/Locking the Tailgate**

**To unlock:** Press the tailgate release button under the tailgate handle to unlock the tailgate. The vehicle can be on or off.

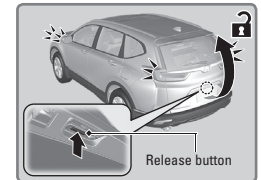

**To lock:** Press the tailgate lock button to lock the tailgate and all doors. If the remote transmitter is inside the vehicle, the tailgate and doors will not lock.

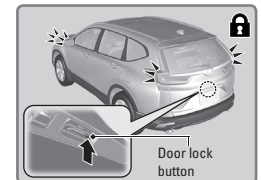

\*if equipped

■ **Walk Away Auto Lock®**

When you walk away from the vehicle while carrying the remote transmitter, the doors and trunk can automatically lock if the following conditions are met:

- The remote transmitter is within a range of 5 feet (1.5 m).
- All doors are closed.
- There is not an additional remote transmitter inside the vehicle.

Follow these steps (see diagram)

1. Carry the remote transmitter while you exit the vehicle. Close all the doors and stay near the vehicle. Listen for a beep. The system is activated.
2. Walk at least 5 feet (1.5 m) away.
3. Listen for a beep and look for the lights to flash. The doors lock.

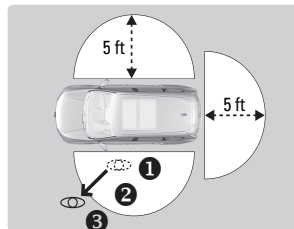

To turn on this feature, follow these steps:

1. From the HOME screen, select Settings.
2. Select Vehicle.
3. Select Door/Window Setup.
4. Select Walk Away Auto Lock.
5. Select On.

■ **Customizing Door Lock Settings**

You can customize the auto door locking/unlocking setting to your liking using the master door lock switch..

**Models with information display**

**Customizing flow for auto door locking options**

Steps	Drive Lock Mode *2	Off
1	Apply the parking brake. Move the shift lever to P.	
2	Close the driver's door.	Open the driver's door.
3	Turn the ignition switch to ON *1.	
4	Move the shift lever out of P with the brake pedal depressed.	—
5	Press and hold the right side of the master door lock switch on the driver's door for more than five seconds. Release the switch after you hear a click twice. 	Press and hold the right side of the master door lock switch on the driver's door for more than five seconds. Release the switch after you hear one click.
6	Move the shift lever to P.	—
7	Turn the ignition switch to ACCESSORY *1 within 20 seconds. Customization is completed.	

\*1:Models with the smart entry system have an **ENGINE START/STOP** button instead of an ignition switch.

\*2:Default setting

**Customizing flow for auto door unlocking options**

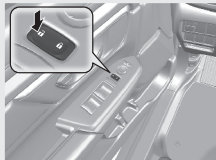
Steps	Driver's Door Open Mode *2	Park Unlock Mode	Off
1	Apply the parking brake. Move the shift lever to P.		
2	Close the driver's door.		Open the driver's door.
3	Turn the ignition switch to ON *1.		
4	Move the shift lever out of P with the brake pedal depressed.	—	
5	Press and hold the left side of the master door lock switch on the driver's door for more than five seconds. Release the switch after you hear a click twice. 		
6	Move the shift lever to P.	—	
7	Turn the ignition switch to ACCESSORY *1 within 20 seconds. Customization is completed.		

\*1:Models with the smart entry system have an **ENGINE START/STOP** button instead of an ignition switch.

\*2:Default setting

**Models with driver information interface**

See Customized Features, page 32.

## Door Operation

Use several methods to lock or unlock the doors.

### ■ Using the Lock Tab

**To unlock:** Pull the lock tab rearward. When you unlock the door using the lock tab on the driver's door, only the driver's door unlocks.

**To lock:** Push the lock tab forward. When you lock the door using the lock tab on the driver's door, all other doors and the tailgate lock.

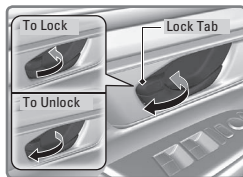

### ■ Using the Front Door Inner Handle

When you pull either front door inner handle, the door unlocks and opens.

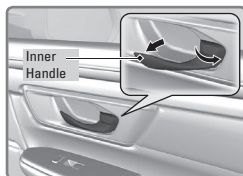

### ■ Using the Master Door Lock Switch

**To unlock:** Press the unlock side of the switch to unlock all doors and the tailgate.

**To lock:** Press the lock side of the switch to lock all doors and the tailgate.

The front passenger's door also has the master door lock switch.

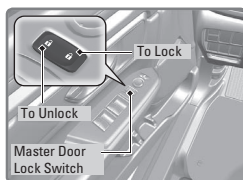

### ■ Childproof Door Locks

The childproof door locks prevent the rear doors from being opened from the inside, regardless of the position of the lock tab.

Slide the lever in the rear door to the lock position, and close the door.

Open the door using the outer door handle.

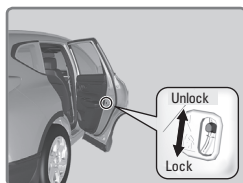

## Tailgate Operation\*

Use these methods to operate the tailgate.

### ■ Opening the Tailgate

Press the tailgate release button and lift up the tailgate to open it.

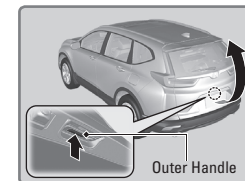

### ■ Closing the Tailgate

Grab the inner handle and pull the tailgate down. Push it closed from the outside.

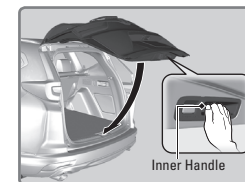

### ■ Power Tailgate Operation\*

Use these methods to operate the power tailgate.

#### ■ Power Tailgate Button

The vehicle must be in Park (P) with all doors unlocked.

Press the power tailgate button for about a second to open the tailgate. Press it again to stop. Press for about a second to then close it.

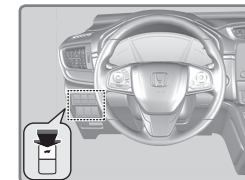

#### ■ Tailgate Inner Button

Press the tailgate inner button to automatically close the tailgate. Press it again to stop. Press again to reverse the tailgate direction.



#### ■ Manual Operation

You can adjust the tailgate position by hand. The tailgate will offer a measure of resistance while being moved, but this is normal.

\*if equipped

**⚠ WARNING**

Closing the power tailgate while anyone is in the path of the tailgate can cause serious injury.

Make sure everyone is away from the tailgate before closing it.

**NOTICE**

Do not push or pull on the power tailgate when it is being automatically opened or closed. Forcibly opening or closing the power tailgate while in operation can deform the tailgate frame.

- **Hands Free Access\***

Use a forward and back kicking motion under the center of the rear bumper to open or close the power tailgate while carrying the smart entry remote.

*If you hold your foot under the bumper for too long, the power tailgate does not open or close.*

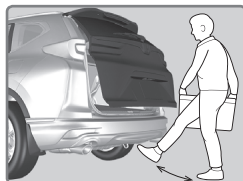

- **Programmable Tailgate Position**

You can set the maximum opening of the tailgate to suit your needs.

1. Adjust the tailgate to your desired position.
2. Press and hold the tailgate inner button until you hear two short beeps and one long beep.



## Rear Cargo Cover\*

Conceal your cargo below a retractable cover.

The retracted roll is held in place by hooks at the left and right edges.

**Extending the cover:** Lift and pull the flap rearward to unhook the roll. Attach the cover to the slots on both sides of the tailgate opening. Do not place items on the cargo cover.

**Retracting the cover:** Remove the cover from the slots and allow it to rewind smoothly. Lift the flap so the hooks can engage. Lower the flap. It will sit flat.



*\*if equipped*

## Power Window Operation

The power windows can be opened and closed when the vehicle is on by using the switches on the doors. The switches on the driver's side can be used to open and close all the windows.

- **Automatic Operation**

**To open:** Push the switch down firmly.

**To close:** Pull the switch up firmly.

The window opens or closes completely. To stop the window at any time, push or pull the switch again briefly.

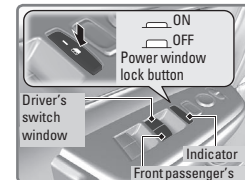

- **Manual Operation**

**To open:** Push the switch down lightly.

**To close:** Pull the switch up lightly.

Release the switch when the windows reach the desired position.

- **Power Window Lock**

Push in the power window lock button so only the driver's window can be operated.

**⚠ WARNING**

Closing a power window on someone's hands or fingers can cause serious injury.

Make sure your passengers are away from the windows before closing them.

## Power Moonroof Operation\*

The moonroof can be opened and closed when the vehicle is on by using the switch on the ceiling.

### ■ Automatic Operation

**To open:** Pull the switch back firmly to the second detent, then release.

**To close:** Push the switch forward firmly to the second detent, then release.

The moonroof opens or closes completely. To stop the moonroof at any time, push the switch briefly.

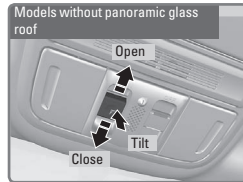

### ■ Manual Operation

**To open:** Pull and hold the switch back to the first detent until the desired position is reached.

**To close:** Push and hold the switch forward to the first detent until the desired position is reached.

### ■ Tilt Operation

**To tilt:** Push the center of the switch.

**To close:** Push the switch forward firmly, then release.

### ⚠ WARNING

Closing the moonroof on someone's hands or fingers can cause serious injury.

Make sure your passengers are away from the moonroof before closing it.

### NOTICE

Opening the moonroof in below freezing temperatures or when it is covered with snow or ice can damage the moonroof panel or motor.

## Panoramic Glass Roof\*

The glass roof can be opened and closed when the vehicle is on by using the switch on the ceiling.

### ■ Automatic Operation

**To open:** Pull the switch back firmly to the second detent, then release.

**To close:** Push the switch forward firmly to the second detent, then release.

The glass roof opens or closes completely. To stop the glass roof at any time, push the switch briefly.

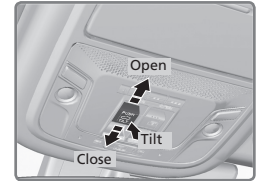

### ■ Manual Operation

**To open:** Pull and hold the switch back to the first detent until the desired position is reached.

**To close:** Push and hold the switch forward to the first detent until the desired position is reached.

### ■ Tilt Operation

**To tilt:** Push the center of the switch.

**To close:** Push the switch forward firmly, then release.

### ⚠ WARNING

Closing the glass roof on someone's hands or fingers can cause serious injury.

Make sure your passengers are away from the glass roof before closing it.

### NOTICE

Opening the glass roof in below freezing temperatures or when it is covered with snow or ice can damage the glass roof panel or motor.



## Center Console Box

Adapt the center console to your storage needs.

Slide the tray forward or back. The tray is handy for storing small items or a phone.

Remove the tray by lifting up the front edge while pushing the tray all the way back.

When reinstalling the tray, take care to install it with the vertical section to the back.

Store the tray by aligning it with the slots at the rear of the console box, then pushing down until the tray locks in place.

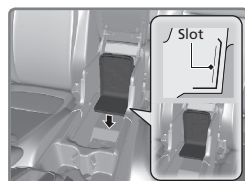
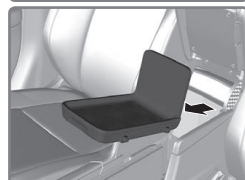
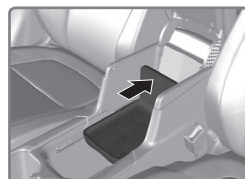
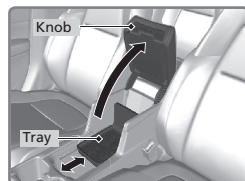

## Interior and Exterior Lights

Operate interior and exterior lights when the vehicle is on or off.

### Brightness Control

Adjust instrument panel brightness when the vehicle is on.

**To brighten:** Turn the knob to the right.

**To dim:** Turn the knob to the left.

A beep sounds when the brightness reaches minimum or maximum.



### Interior Lights

Change the interior light settings using the switch on the ceiling.

**ON position:** Interior lights remain on.

**Door-activated position:** Interior lights come on when any of the doors are opened, the driver's door is unlocked, or the vehicle is turned off.

**OFF position:** Interior lights remain off.

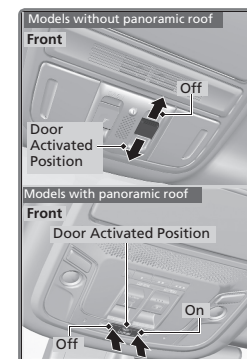

### Map Lights

Press the front map lights to turn on or off.

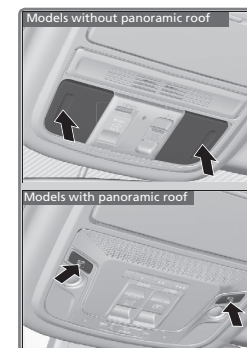

■ **Cargo Area Lights**

Located on the rear ceiling in front of the tailgate.

**ON position:** Cargo area lights are on when the tailgate is open.

**OFF position:** Cargo area lights remain off.

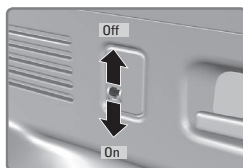

■ **Exterior Lights**

Rotate the switches on the headlight lever to operate the exterior lights. Push the lever forward to turn on the high beams. Return the lever to its original position for low beams.

**OFF:** All exterior lights are off.

Turn on exterior lights except headlights.

**AUTO:** Turn on the automatic lighting feature\*. Headlights turn on or off depending on ambient brightness when the vehicle is on. Headlights automatically come on after the wipers are engaged for a certain time.

Turn on all exterior lights including headlights.

Turn fog lights\* on or off.

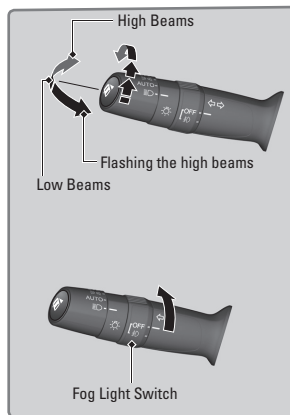

**One-Touch Turn Signal**

Use this quick and convenient method to signal a lane change.

Lightly push the turn signal lever up or down for a three-blink sequence.

For a continuous signal, push the lever up or down until it locks into place.

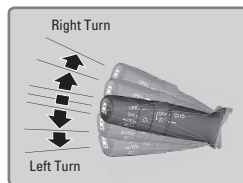

**Auto High-Beam System\***

Automatically changes the low beam headlights to high beam headlights when necessary.

■ **How It Works**

When you are driving at night above 25 mph (40 km/h) and the headlight lever is in the low beam position with the switch rotated to AUTO, the system changes between low and high beams depending on the surrounding conditions.

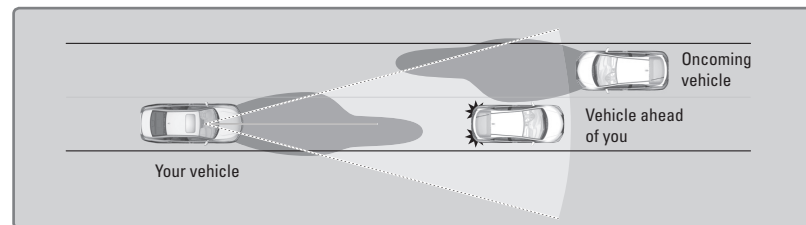

If a vehicle is detected ahead of you, the headlights stay in low beams. If the system does not detect any vehicles ahead of you, the headlights change to high beams.

Certain conditions, such as weather and brightness of other vehicles' lights, can affect system operation.

■ **Turning the System On or Off**

Make sure the headlight lever is in the low beam position with the switch rotated to the AUTO position. The auto high-beam system indicator appears when the system is on.

The system cancels temporarily when you drive at speeds below 15 mph (24 km/h) for an extended period of time, the vehicle falls below 6 mph (10 km/h), the windshield wipers run at high speed for more than a few seconds, or enter a well lit location.

*To disable the system:* When the vehicle is on and parked, pull the headlight lever towards you and hold it for 40 seconds.

*To re-enable the system:* Pull the headlight lever towards you and hold it for 30 seconds.

*To temporarily cancel operation,* do either of the following:

- Flash the high beams once by moving the lever toward you. Flash the high beams again to resume auto high beam operation.
- Turn on the high-beams by pushing the lever forward until you hear a click. Return the stalk to the low beam position to resume auto high beam operation.

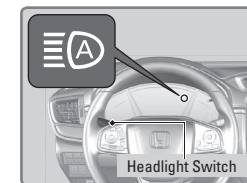

\*if equipped

\*if equipped

If you find the timing of beam changes inconvenient for driving, change the headlight beams manually.

For the system to work properly:

- Do not place an object that reflects light on the dashboard.
- Keep the windshield around the camera clean. When cleaning the windshield, be careful not to apply windshield cleanser to the camera lens.
- Do not attach an object, sticker or film in the area around the camera.
- Do not touch the camera lens.

If the camera receives a strong impact or requires repair of the area near the camera, consult a dealer.

If you see the message “ Some Driver Assist Systems Cannot Operate: Clean Front Windshield,” park your vehicle in a safe place. Wipe away debris blocking the windshield, then start driving again. If the message remains even after driving for a while with the clean windshield, have your vehicle checked by a dealer.

If the  message appears:

- Use the climate control system to cool down the interior and, if necessary, also use the defroster mode with the air flow directed towards the camera.
- Start driving the vehicle to lower the windshield temperature, which cools down the area around the camera.

## Wiper Operation

The windshield wipers and washers can be used when the vehicle is on.

### ■ Front Wipers

Move the wiper lever up or down to the desired position.

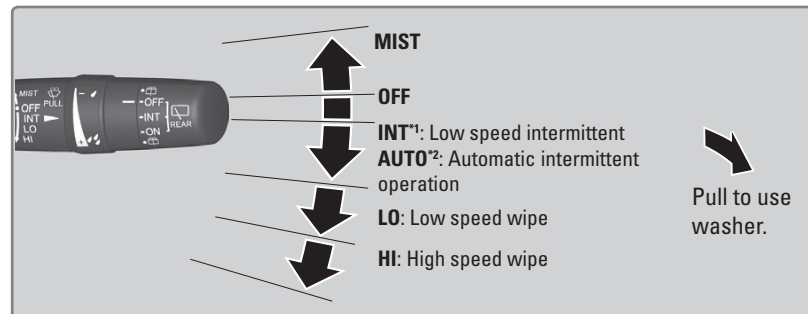

### ■ Intermittent (INT) Wipers<sup>1</sup>

When you move the lever to the INT position, the wipers operate based on the delay adjustment.

Rotate the adjustment ring to adjust the wiper delay.

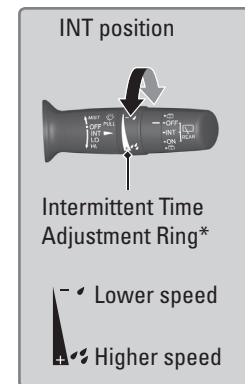

*\*1 models without automatic intermittent wipers*

*\*2 models with automatic intermittent wipers*

*\*if equipped*

■ **Automatic (AUTO) Intermittent Wipers<sup>2</sup>**

When you move the lever to the AUTO position while driving in rainy weather, the wipers operate based on the amount of detected rainfall.

Put the lever in the AUTO position only when driving in rainy weather.

Rotate the adjustment ring to adjust the rainfall sensor sensitivity.

Return the lever to the OFF position when rain stops.

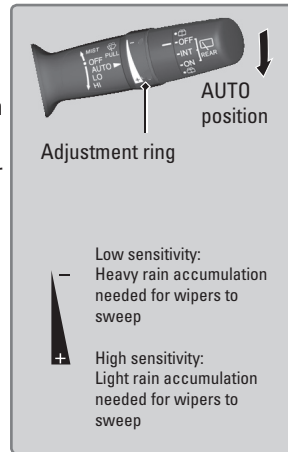

**NOTICE**

Always ensure the wiper lever is in the OFF position before entering a car wash to prevent severe damage to the windshield wiper system.

■ **Rear Wiper**

When you shift to Reverse (R) and the front wipers are activated, the rear wiper activates even if the switch is off.

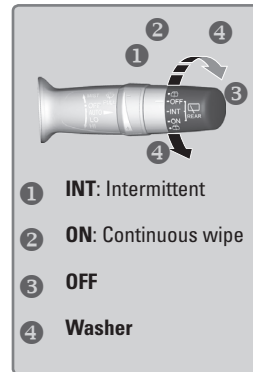

**NOTICE**

Do not use the wipers when the windshield is dry. The windshield will get scratched, or the rubber blades will get damaged.

In cold weather, the blades may freeze to the windshield, becoming stuck. Operating the wipers in this condition may damage the wipers. Use the defroster or heated windshield button\* to warm the windshield, or manually clear the windshield of ice and snow before turning on the wipers.

\*if equipped

**Adjusting the Seats**

Make seat adjustments before driving to ensure the best comfort and safety.

■ **Adjusting the Front Seats**

Adjust the driver's seat as far back as possible while allowing you to maintain full control of the vehicle. You should be able to sit upright and well back in the seat, adequately press the pedals without leaning forward, and grip the steering wheel comfortably. The passenger's seat should be adjusted so that it is as far back from the front airbag in the dashboard as possible.

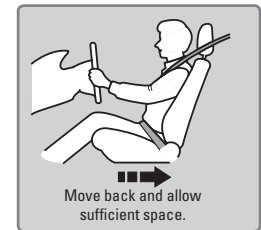

The National Highway Traffic Safety Administration and Transport Canada recommend that drivers allow at least 10 inches (25 cm) between the center of the steering wheel and the chest.

**Driver's Power Seat\***

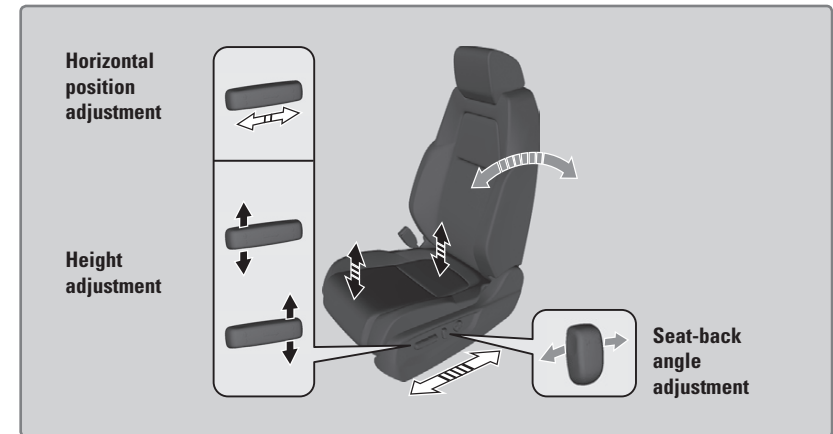

**Power Lumbar Support\***

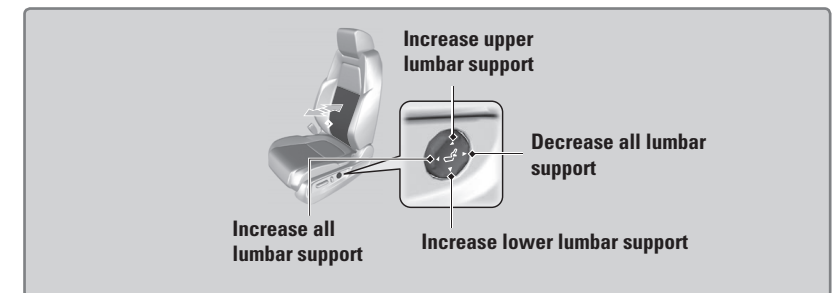

\*if equipped

Manual seats\*



**⚠ WARNING**

Reclining the seat-back too far can result in serious injury or death in a crash.  
Adjust the seat-back to an upright position, and sit well back in the seat.

**⚠ WARNING**

Sitting too close to a front airbag can result in serious injury or death if the front airbags inflate.  
Always sit as far back from the front airbags as possible while maintaining control of the vehicle.

**⚠ WARNING**

Sitting improperly or out of position can result in serious injury or death in a crash.  
Always sit upright, well back in the seat, with your feet on the floor.

■ **Adjusting the Head Restraints**

Your vehicle is equipped with head restraints in all seating positions. Head restraints are most effective for protection against whiplash and other rear-impact crash injuries.

The center of the back of the occupant's head should rest against the center of the restraint. The tops of the occupant's ears should be level with the center height of the restraint.

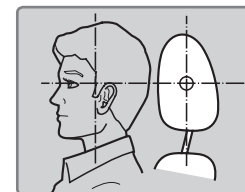

**Front and rear center seat head restraints**

**To raise the head restraint:** Pull it upward.

**To lower the head restraint:** Push it down while pressing the release button.

**To remove the head restraint:** Pull the restraint up as far as it will go. Then push the release button, and pull the restraint up and out.

**To reinstall a head restraint:** Insert the legs back in place, then adjust the head restraint to an appropriate height while pressing the release button. Pull up on the restraint to make sure it is locked in position.

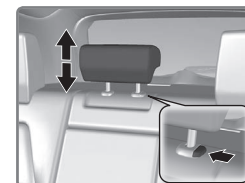
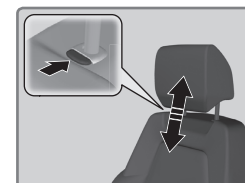

For the head restraint system to work properly:

- Do not hang any items on the head restraints, or from the restraint legs.
- Do not place any object between an occupant and the seat-back.
- Install each restraint in its proper location.

**⚠ WARNING**

Improperly positioning head restraints reduces their effectiveness and increases the likelihood of serious injury in a crash.  
Make sure head restraints are in place and positioned properly before driving.

**⚠ WARNING**

Failure to reinstall, or correctly reinstall, the head restraints can result in severe injury during a crash.

Always replace the head restraints before driving.

**■ Floor Mats**

Position the front seat floor mats properly and anchor them. If they are not properly positioned, the floor mats can interfere with the front seat functions.

**Do not put additional floor mats on top of the anchored mats.**

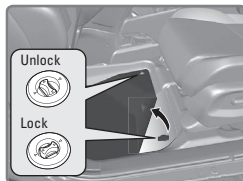
**Rear Seats**

Fold down rear seats to allow for additional storage space.

**■ Folding Down Rear Seats**

1. Store the center seat belt. Insert the latch plate into the slot on the side of the anchor buckle. Retract the seat belt into the holder on the ceiling.
2. Lower the center head restraint to its lowest position. Put the armrest back into the seat-back.
3. **From the rear seat side:** Pull the release lever.  
**From the cargo area side:** Pull the release lever.

Make sure all items in the cargo area or items extending to the rear seats are properly secured. Loose items can fly forward if you have to brake hard.

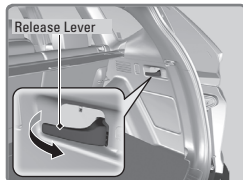
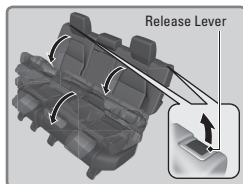
**Under-Floor Storage Area**

The under-floor storage area height is adjustable. Set the floor panel in the lower position for maximum floor-to-ceiling height or in the upper position for a flat cargo floor.

1. Remove the cargo area floor panel.



2. Place the front of the panel on the appropriate support. Lower the rear of the panel into place.

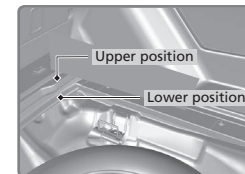

## Driving Position Memory System\*

You can store two driver's seat positions (except for power lumbar) with the driving position memory system.

When you unlock and open the driver's door with a remote, the seat adjusts automatically to one of the two preset positions.

When you enter the vehicle, the driver information interface briefly shows you which remote transmitter you used to unlock the vehicle.

- **DRIVER 1** transmitter is linked to memory button 1.
- **DRIVER 2** transmitter is linked to memory button 2.

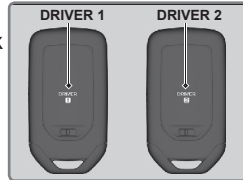

You can use the buttons on the driver's door to store two driver's seat positions into memory (except for power lumbar) when the vehicle is on.

1. Adjust the seat to your preferred position.
2. Press SET.
3. Press and hold memory button 1 or 2. You will hear two beeps when the memory is set.
4. Press one of the memory buttons to recall previously stored positions.

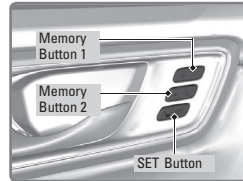

## Adjusting the Steering Wheel

The steering wheel height and distance from your body can be adjusted so that you can comfortably grip the steering wheel in an appropriate driving posture.

1. Pull up the steering wheel adjustment lever.
2. Move the steering wheel up or down, and in or out.
3. Push down the steering wheel adjustment lever to lock the steering wheel in position.

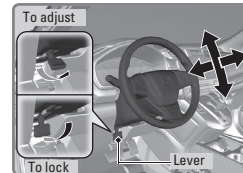

### **⚠ WARNING**

Adjusting the steering wheel position while driving may cause you to lose control of the vehicle and be seriously injured in a crash.

Adjust the steering wheel only when the vehicle is stopped.

\*if equipped

## Adjusting the Mirrors

Adjust the angle of the mirrors for the best visibility when you are sitting in the correct driving position.

### ■ Rearview Mirror with Day/Night Positions\*

Manually adjust the position to reduce headlight glare from vehicles behind you. Flip the tab to switch between day and night positions.

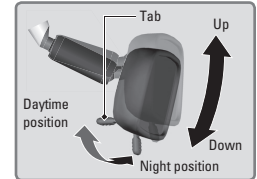

### ■ Automatic Dimming Rearview Mirror\*

When driving after dark, the automatic dimming function reduces the glare from headlights behind you. The function cancels when the shift lever is in Reverse (R).

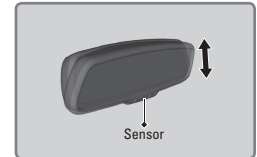

### ■ Power Door Mirrors

Adjust the power door mirrors when the vehicle is on.

**L/R selector switch:** Select the left or right mirror. After adjusting the mirror, return the switch to the center position.

**Mirror position adjustment switch:** Press the switch left, right, up, or down to move the mirror.

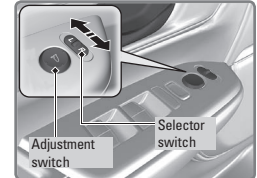

\*if equipped



## HomeLink® Universal Transceiver\*

**U.S. models only.** Program your vehicle to operate up to three remote-controlled devices around your home—such as garage doors, lighting, or home security systems—using the buttons on the ceiling.

### ■ Training a Button

Park near the system you want to program, and follow the instructions in the flowchart below.

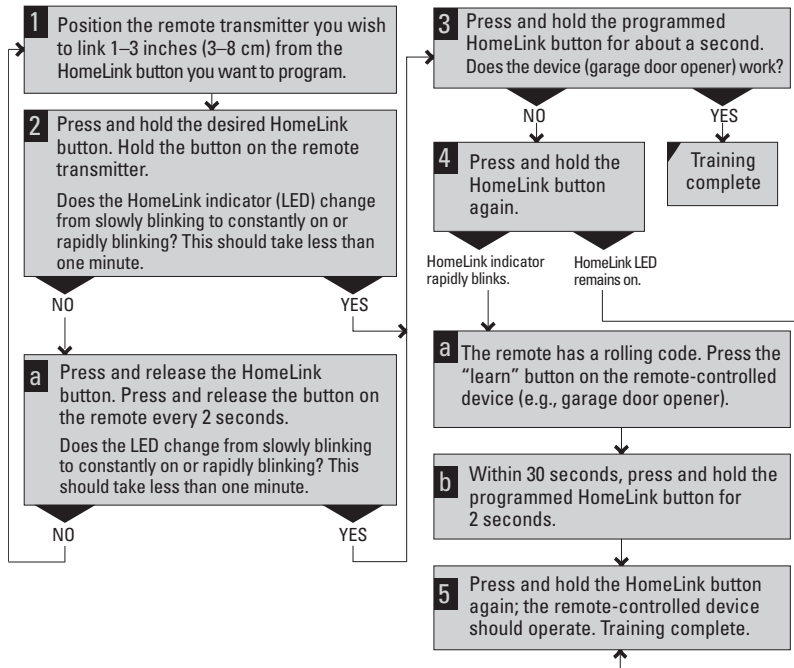
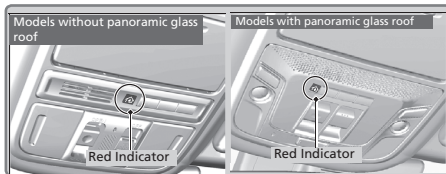

To retrain a button or erase codes, see the Owner's Manual at [owners.honda.com](http://owners.honda.com). If you need help, visit [www.homelink.com](http://www.homelink.com) or call (800) 355-3515.

\*if equipped

## Climate Control System

The automatic climate control system can maintain your preferred interior temperature by selecting the proper mix of heated or cooled air and fan speed. Use the buttons on the dashboard to control the system.

### Models without SYNC button

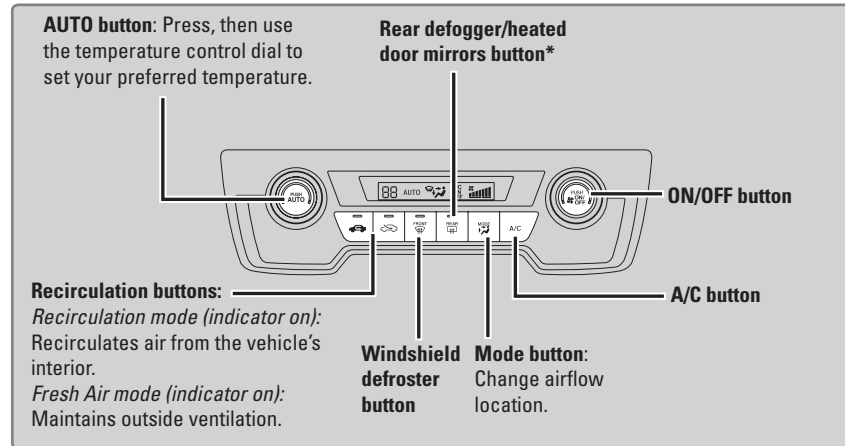

### Models with SYNC button

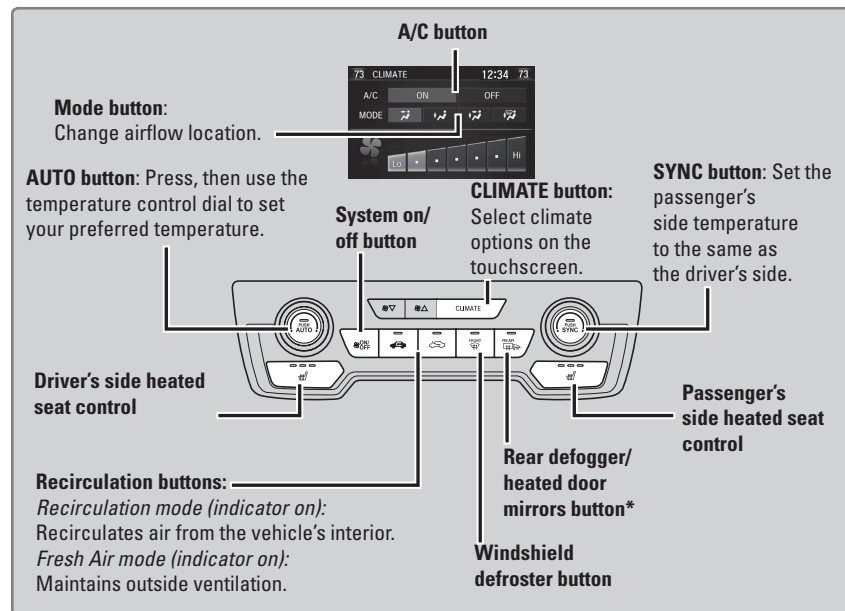

\*if equipped

■ **Heated Windshield Button\*\***

Press the heated windshield button to deice the windshield when the vehicle is on.

When the outside temperature is below 4°C, the heated windshield may automatically activate. The system deactivates itself once the outside temperature reaches 6°C.

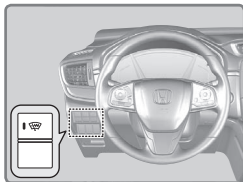

■ **Heated Steering Wheel\* \*\***

Press the button to heat the steering wheel when the vehicle is on. Press the button again to turn off heating.

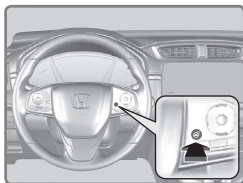

**Seat Heaters\***

Quickly warm the seats when the vehicle is on.

Press a seat heater switch in the front console (front seats) or on the rear-seat armrests\*\* (rear-outer seats) to cycle through the heat settings.

After a period of time, the heat setting will reduce until the heater shuts off.

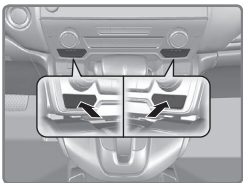

**⚠ WARNING**

Heat-induced burns are possible when using seat heaters.

Persons with a diminished ability to sense temperature (e.g., persons with diabetes, lower-limb nerve damage, or paralysis) or with sensitive skin should not use the seat heaters.

\*if equipped  
\*\*Canadian models

**Setting the Clock**

Adjust the time using the steps described for your vehicle type. On vehicles with navigation, the time is automatically set using GPS signals.

**Models with color audio system**

Use the selector knob to make and enter selections.

1. Press and hold the MENU/CLOCK button.
2. Select the hour and adjust as necessary.
3. Select the minutes and adjust as necessary.
4. Select Set when complete.

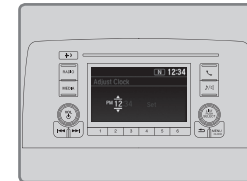

**Models with Display Audio**

Touch items to make selections. On vehicles with navigation, the time is automatically set using GPS signals.

1. From the HOME screen, select Settings.
2. Select Clock.
3. Select Clock Adjustment.
4. Adjust the hour and minute values.
5. Select OK when complete.

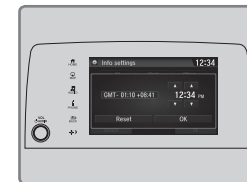

\*if equipped

# AUDIO AND CONNECTIVITY

Learn how to operate the vehicle's audio system.

## Basic Audio Operation

Connect audio devices and operate the audio system.

### ■ USB Ports

Connect a USB flash drive or other audio device, such as an iPod or iPhone®. Install the flash drive or cable connector to the USB port.

#### Models with color audio system

The USB port (1.0A) in the center console is for playing audio from a USB device, connecting a cellular phone, and charging devices.

#### Models with Display Audio

The USB port (1.5A) in the the center console is for playing audio, charging devices, and connecting to Apple CarPlay (see page 75) or Android Auto (see page 76).

Additional charging-only ports are on the back of the center console compartment\*.

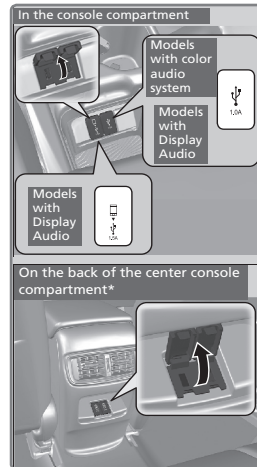

*iPod and iPhone are trademarks of Apple, Inc.*

### ■ Accessory Power Sockets

Open the socket cover in the front console to use power when the vehicle is on. An additional power socket is in the center console.

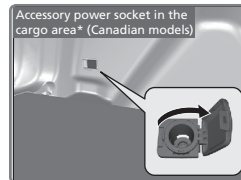
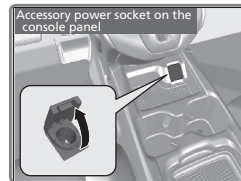

### NOTICE

Do not insert an automotive type cigarette lighter element. This can overheat the power socket.

*\*if equipped*

### ■ Steering Wheel Controls

You can operate certain functions of the audio system using the steering wheel controls.

#### Models with Color Audio

**SOURCE button:** Cycle through available audio modes.

**+ / - buttons:** Adjust audio volume.

**◀ / ▶ buttons:** Change presets, tracks, albums, or folders.



#### FM/AM Radio

Press **◀** or **▶** for the next or previous preset station.

Press and hold **t** or **u** to seek the next or previous strong station.

#### iPod/USB/Bluetooth Audio

Press **◀** or **▶** for the next or previous track.

Press and hold **◀** or **▶** for the next or previous folder (USB).

#### Models with Driver Information Interface

**ⓘ button:** Press until the audio screen is displayed in the Driver Information Interface.

**+ / - bar:** Press the ends of the bar or slide to adjust audio volume.

**◀ / ▶ buttons:** Change presets, tracks, albums, or folders.



**ENTER button:** Make audio selections in the Driver Information Interface.

#### FM/AM/SiriusXM Radio\*

Press **◀** or **▶** for the next or previous preset station.

Press and hold **◀** or **▶** to seek the next or previous strong station.

#### iPod/USB/Bluetooth Audio

Press **◀** or **▶** for the next or previous track.

Press and hold **◀** or **▶** for the next or previous folder (USB).

#### Pandora\*

Press **▶** for the next song.

Press and hold **◀** or **▶** for the previous or next station.

*\*if equipped*

## ■ Steering Wheel Controls (continued)

### Models with Display Audio (continued)

From the audio screen in the Driver Information Interface:

#### FM/AM/SiriusXM Radio\*

Press the ENTER button to display a preset list. Press ▲ or ▼ to scroll the list and press the ENTER button to select a preset.

#### USB Flash Drive

Press the ENTER button to display the folder list. Press ▲ or ▼ to scroll the list and press the ENTER button to select a folder. Repeat to select a track.

#### iPod

Press the ENTER button to display the iPod list. Press ▲ or ▼ to scroll the category and press the ENTER button to select an item. Repeat to select a track.

#### Bluetooth Audio

Press the ENTER button to display the track list. Press ▲ or ▼ to scroll the list and press the ENTER button to select a track.

#### Pandora\*

Press the ENTER button to display the station list. Press ▲ or ▼ to scroll the list and press the ENTER button to select a station.

## ■ Adjusting the Sound

Adjust various sound settings.

### Models with color audio system

1. Use the selector knob to make and enter selections.
2. Press the Sound button.
3. Select a sound mode to change, and adjust it using the selector knob.
4. Press the Back button to exit the menu.

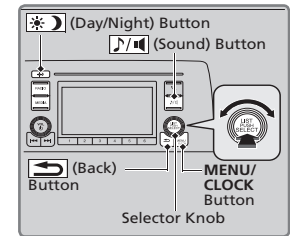

### Models with Display Audio

1. Make and enter selections using the touchscreen.
2. From the audio screen, select Menu.
3. Select Sound.
4. Select the tabs to change the sound mode and adjust the setting.
5. Select OK when complete.

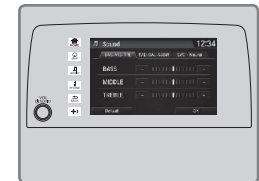

## Models with Color Audio System

### Color Audio System

Use the buttons to control the display and audio system.

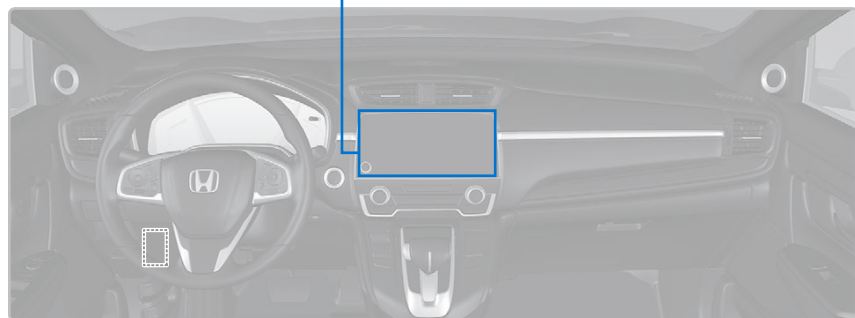
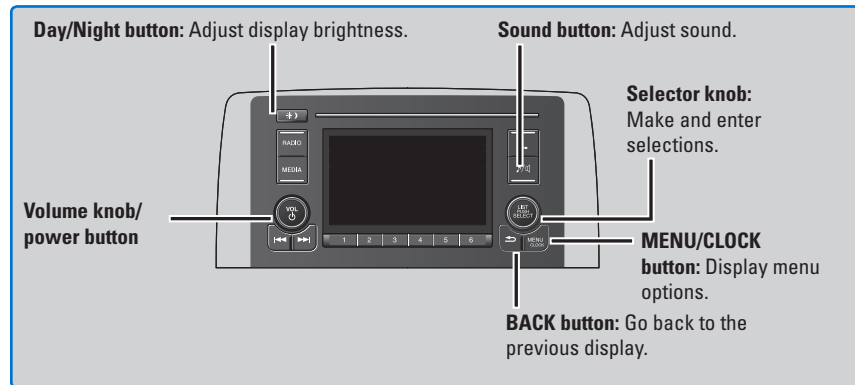

## Models with color audio system

### FM/AM Radio

Play FM or AM radio stations.

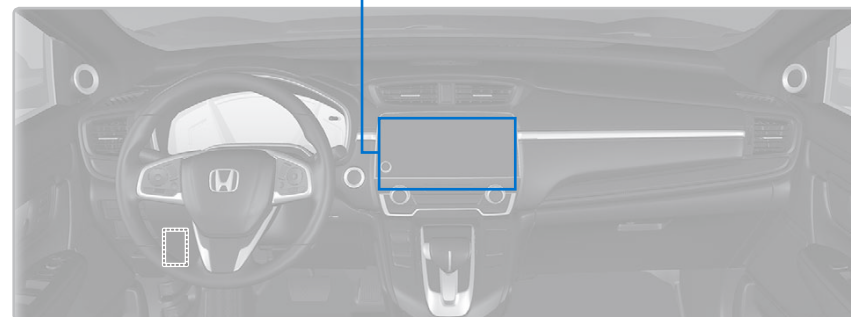
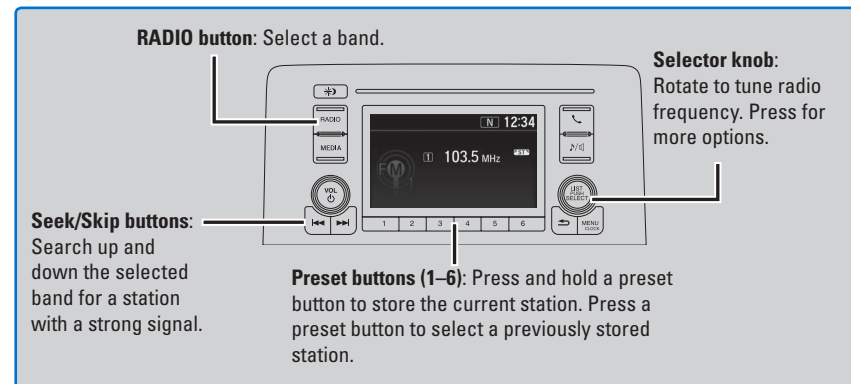

Models with color audio system

iPod®

Play and operate an iPod through the vehicle's audio system. Connect your device to the USB port (see page 62).

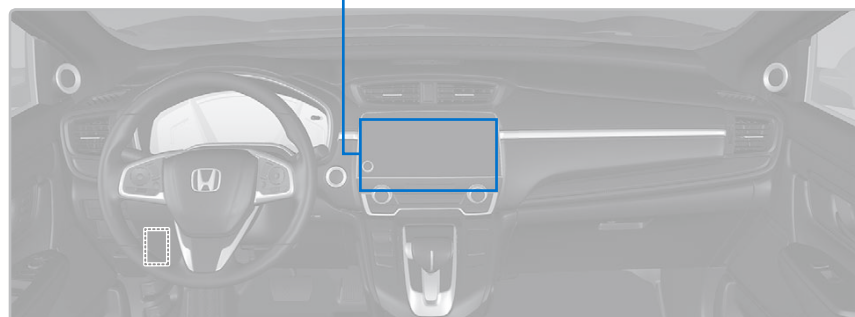
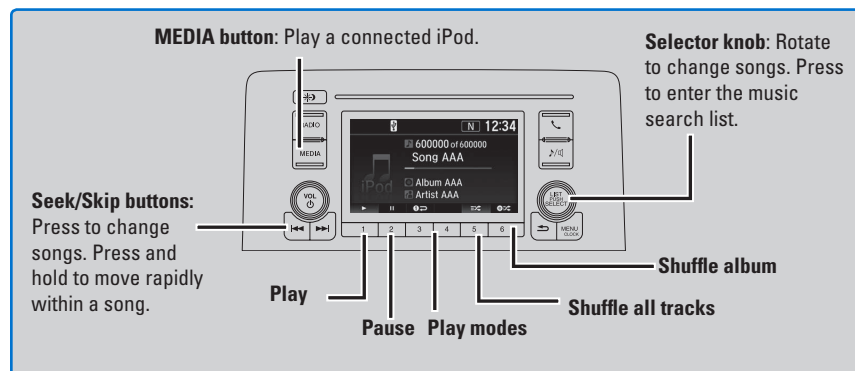

■ Searching for Music

Use the selector knob to display and search through a playlist stored on the iPod.

1. From the audio screen, press the selector knob.
2. Select a search option.
3. Select the item you want to play.

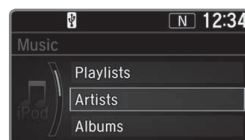

iPod is a trademark of Apple, Inc.

Models with color audio system

USB Flash Drive

Play and operate a USB flash drive through the vehicle's audio system. Connect your device to the USB port (see page 62).

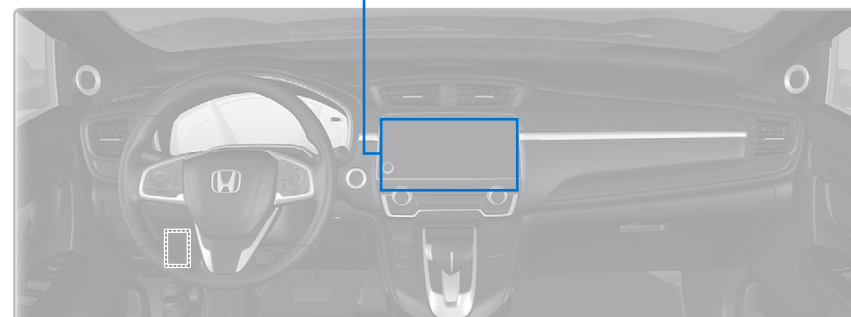
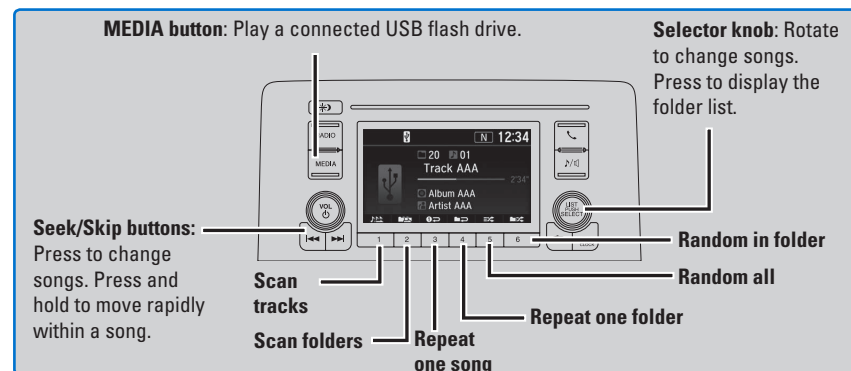

■ Searching for Music

Use the selector knob to display and search through folder lists stored on the flash drive.

1. From the audio screen, press the selector knob.
2. Select a folder.
3. Select the file you want to play.

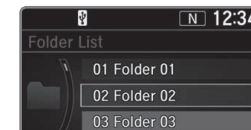



Models with color audio system

**Pandora®**

Play and operate Pandora from your compatible phone through the vehicle's audio system. Visit [automobiles.honda.com/handsfreelink/](http://automobiles.honda.com/handsfreelink/) (U.S.) or phone (888) 528-7876 (U.S. and Canada) to check phone compatibility. Standard data rates apply with your phone service provider.

Connect your phone when the vehicle is stopped. Disruptions in your phone's cell signal can affect audio playback.

**For iPhone:**

- Connect via *Bluetooth* HandsFreeLink (see page 84) or USB port (see page 62).
- A pop-up may appear on your phone requesting you to allow access for Pandora to be launched.
- If you cannot operate Pandora through the audio system, it may be streaming through *Bluetooth* Audio. Make sure Pandora is selected on the audio system.
- If Pandora still does not operate, try rebooting the phone and reconnecting the cable if necessary.

**For other compatible smartphones:**

- Connect via *Bluetooth* HandsFreeLink (see page 62).

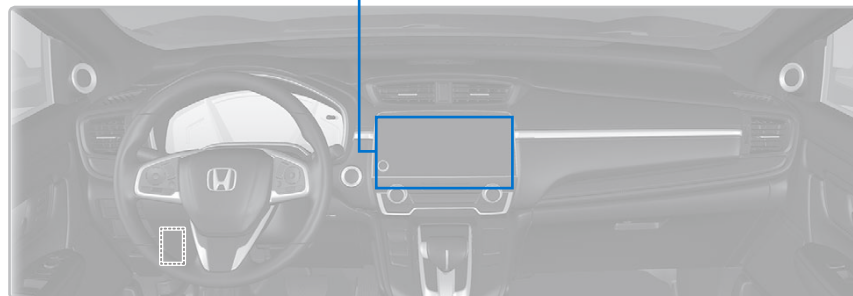
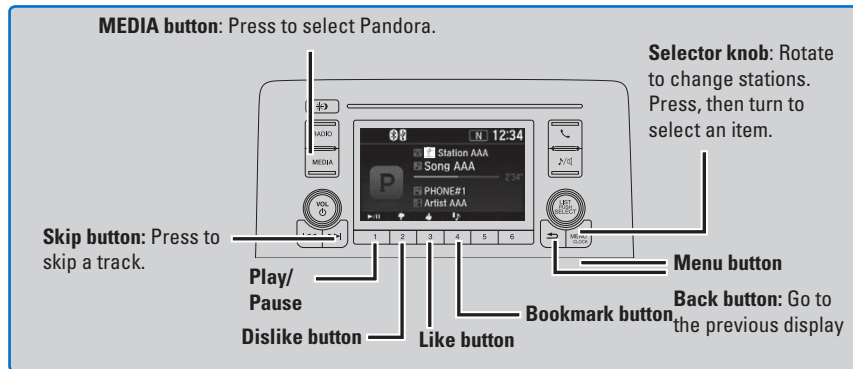

Models with color audio system

**Bluetooth® Audio**

Play streaming or stored audio from your compatible phone through the vehicle's audio system. Visit [automobiles.honda.com/handsfreelink/](http://automobiles.honda.com/handsfreelink/) (U.S.) or phone (888) 528-7876 (U.S. and Canada) to check phone compatibility. Standard data rates apply with your phone service provider. Connect your phone to *Bluetooth* HandsFreeLink (see page 84).

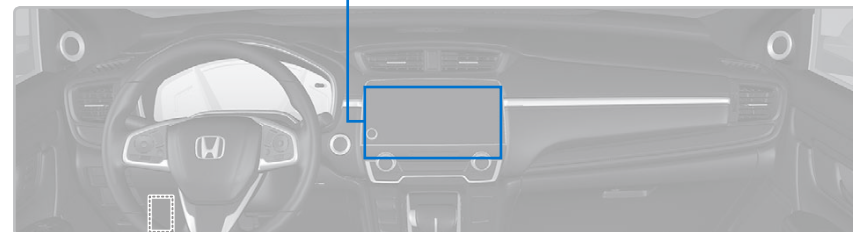
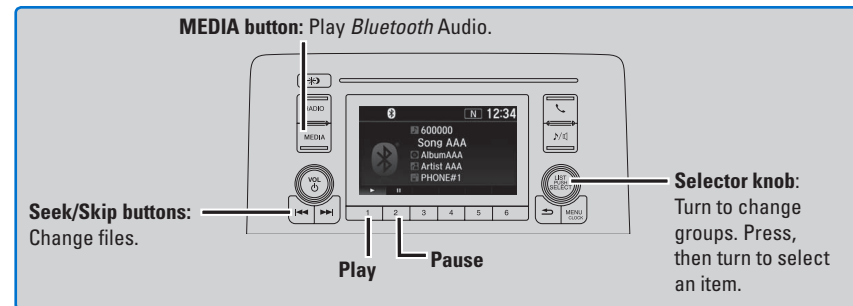

■ **Searching for Music**

Use the selector knob to search for tracks stored on the device.

1. Press the MEDIA button until Bluetooth Audio mode is selected, then press the selector knob.
2. Select a category.
3. Select the item you want to play.

**Notes:**

- To play the audio files, you may need to operate your phone.
- Some functions may not be available on some devices.
- The pause function may not be available on some phones.
- In some cases, the name of the artist, album, or track may not appear correctly.

*Applicable laws may prohibit the operation of handheld electronic devices while operating a vehicle. Launch streaming audio on your phone only when safe to do so.*



## Display Audio Operation

Use simple gestures—including touching, swiping, and scrolling—to operate certain audio functions.

Some items may be grayed out during driving to reduce the potential for distraction. You can select them when the vehicle is stopped or use voice commands\*.

Wearing gloves may limit or prevent touchscreen response.

You can use a microfiber cleaning cloth to remove dust or fingerprints from the touchscreen.

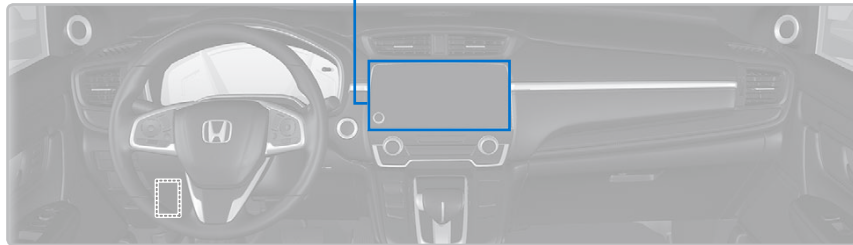
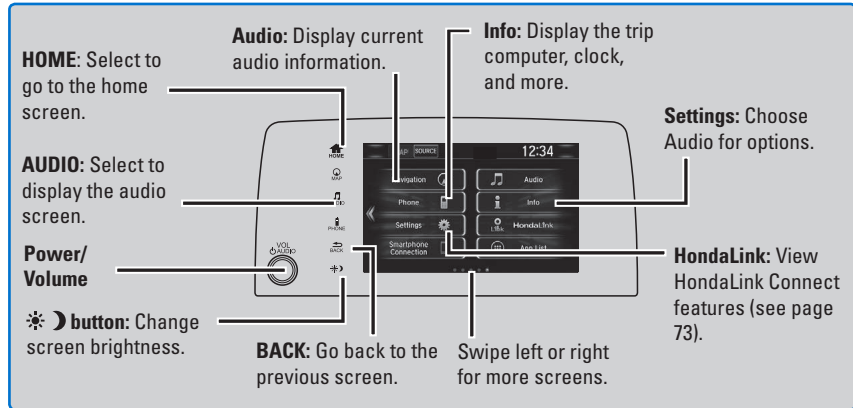

### Setting Touchscreen Sensitivity

You can adjust the touchscreen's sensitivity to your fingertip.

1. From the HOME screen, select Settings, then System.
2. Select Display, then Touch Panel Sensitivity.
3. Make your selection.

## Models with Display Audio

### HondaLink®

Provides you with useful information about your vehicle directly from Honda.

Visit [automobiles.honda.com/handsfreelink/](http://automobiles.honda.com/handsfreelink/) (U.S.) or phone (888) 528-7876 (U.S. and Canada) to check phone compatibility. Standard data rates may apply with your phone service provider.

To get more information on HondaLink, visit [www.hondalink.com](http://www.hondalink.com) (U.S.) or [honda.ca/hondalink](http://honda.ca/hondalink) (Canada).

### HondaLink Connection

Follow the steps below to connect to HondaLink and use its features.

1. Download the HondaLink Connect app to your compatible smartphone.
2. Pair your phone to Bluetooth HandsFreeLink (see page 88).
3. From the HOME screen, select HondaLink.
4. Certain features require you to send vehicle information to Honda. Select Enable Once, Always Enable, or Cancel.



### HondaLink Menu

Select a menu option.

**Places\*:** Displays restaurants, gas stations, Honda dealers, etc. and provides navigation instructions to those locations via the navigation system.

**Vehicle:** Displays instruction messages when the vehicle needs service.

**Help & Support:** Display tips for vehicle usage, get roadside assistance, or contact customer service.

**Messages from Honda:** Displays helpful and important information from Honda. If you have a new message, a yellow envelope icon appears at the top of the screen and a beep sounds. You can swipe down to view the message from any screen.

**Weather\*:** Displays a weekly five-day weather forecast for any location.



## Models with Display Audio

## HondaLink® Assist

If your vehicle's airbags deploy or if the unit detects that the vehicle is severely impacted, your vehicle automatically attempts to connect to an operator. Your phone must be paired to the system and have good cellular connection. Visit [www.hondalink.com](http://www.hondalink.com) (U.S.) or [honda.ca/hondalinkassist](http://honda.ca/hondalinkassist) (Canada) for more information.

1. Make sure your phone is on and paired to *Bluetooth HandsFreeLink* (see page 88).
2. Select Call Now, or the system automatically connects after 10 seconds. The vehicle information and its position may be sent to the operator.\*
3. Select Talk Now to immediately talk to the operator.
4. When the call is complete, select Hang Up or press the Hang-Up/Back button on the steering wheel.

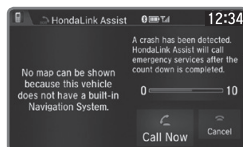

## Wi-Fi Connection

You can connect the audio system to the internet using Wi-Fi and use online services through the touchscreen. If your compatible phone has hotspot capabilities, the system can be tethered to the phone. Follow the steps below to set up Wi-Fi when the vehicle is stopped. Standard data rates apply with your phone service provider.

1. From the Home screen, select Settings.
2. Select Bluetooth/Wi-Fi. Select the Wi-Fi tab.
3. Select Wi-Fi On/Off Status, select Next, then select On.
4. Select Yes.
5. Select Wi-Fi Device List. Make sure your phone's Wi-Fi setting is in access point (tethering) mode.
6. Select the phone you want to connect to the system. If the phone you want to connect does not appear, select Scan.
7. Select Add.
8. Enter a password for your phone, if necessary. Select Done. The Wi-Fi symbol is displayed on the list when connection is successful.



\*Depending on your phone and cellular signal capability, your vehicle's location may not be sent to the operator.

## Models with Display Audio

## Apple CarPlay™

Connect an Apple CarPlay-compatible iPhone to the system. You can use the touchscreen to make a phone call, listen to music, and more. Visit the Apple CarPlay website for more information.

When your iPhone is connected to Apple CarPlay, it is not possible to use the *Bluetooth Audio* or *Bluetooth HandsFreeLink*. However, other previously paired phones can stream audio via *Bluetooth* while Apple CarPlay is connected.

Park in a safe place before connecting your iPhone and launching any compatible apps.

1. Connect the iPhone to the center-console USB port (1.5A) (see page 62).
2. Apple CarPlay requires you to send vehicle information to Honda. Select Enable Once, Always Enable, or Cancel. Your phone may prompt you to allow access for CarPlay to be launched.
3. From the HOME screen, select Apple CarPlay.
4. Select a menu option.

**Phone:** Access your contacts, make phone calls, or listen to voicemail. While connected to Apple CarPlay, calls can only be made through Apple CarPlay, not through Bluetooth HandsFreeLink.

**Music:** Play music stored on your iPhone.

**Maps:** View a map and operate navigation. You can only use Apple CarPlay or the pre-installed navigation system to set a destination with routing guidance.

**Messages:** View and reply to text messages, or have messages read to you aloud by the system.

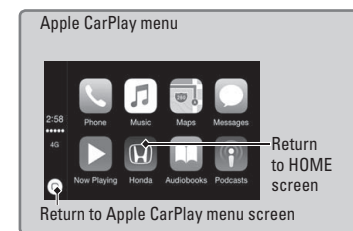
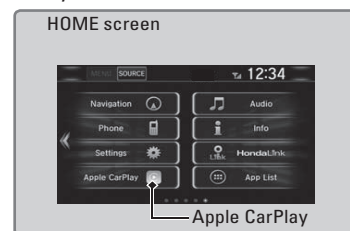

Once connected, press and hold the Talk button on the steering wheel (see page 86) to operate the system using voice commands with Siri Eyes Free

*Depending on use, Apple CarPlay can share certain vehicle information (e.g., vehicle location, speed, and other operating conditions) with the connected iPhone. See Apple's privacy policy for details regarding Apple's use and handling of data uploaded by CarPlay. Use of CarPlay is at user's own risk, and is subject to agreement to the CarPlay terms of use, which are included as part of the Apple iOS terms of use. CarPlay vehicle integration is provided "as is," and Honda cannot guarantee CarPlay operability or functionality now or in the future due to, among other conditions, changes in CarPlay software/Apple iOS, service interruptions, or incompatibility or obsolescence of vehicle-integrated hardware or software. See dealer for details. Only use CarPlay when conditions allow you to do so safely. See your Owner's Manual at [owners.honda.com](http://owners.honda.com) (U.S.) for further license and warranty terms.*

## Models with Display Audio

## Android Auto™

Connect a compatible Android phone to the system. You can use the touchscreen to make a phone call, listen to music, and more. Visit the Android Auto website for more information.

When your Android phone is connected to Android Auto, it is not possible to use the *Bluetooth* Audio. However, other previously paired phones can stream audio via *Bluetooth* while Android Auto is connected.

Park in a safe place before connecting your Android smartphone and launching any compatible apps.

1. Download the Android Auto app to your phone.
2. Connect the phone to the center-console USB port (1.5A) (see page 62). The phone is automatically paired. A tutorial also appears.
3. From the HOME screen, select Android Auto.
4. Android Auto requires you to send vehicle information to Honda. Select Enable Once, Always Enable, or Cancel.
5. Select a menu option.



- a. Maps (Navigation):** View Google Maps and operate navigation. You can only use this system or the pre-installed navigation system to set a destination with routing guidance. You cannot enter destinations using the keyboard while the vehicle is moving.
- b. Phone (Communication):** Make and receive phone calls, as well as listen to voicemail. While connected to Android Auto, calls can only be made through Android Auto, not through *Bluetooth* HandsFreeLink.
- c. Google Now (Home Screen):** Display useful information organized by Android Auto into simple cards that appear only when needed.
- d. Music and audio:** Play music from compatible apps. Select this icon to switch between music apps.
- e. Go back to the HOME screen:** Go back to the vehicle system HOME screen.
- f. Voice:** Use voice commands via Google Voice Search to operate Android Auto. You can also press and hold the Talk button on the steering wheel (see page 86) to say voice commands.

Depending on use, Android Auto can share certain vehicle information (e.g., vehicle location, speed, and other operating conditions) with Google and its service providers. See Google privacy policy for details regarding Google's use and handling of data uploaded by Android Auto. Use of Android Auto is at user's own risk, and is subject to agreement to the Android Auto terms of use, which are presented to the user when the Android Auto application is downloaded to the user's Android phone. Android Auto vehicle integration is provided "as is," and Honda cannot guarantee Android Auto operability or functionality now or in the future due to, among other conditions, changes in Android Auto software/Android operating system, service interruptions, or incompatibility or obsolescence of vehicle-integrated hardware or software. See dealer for details. Only use Android Auto when conditions allow you to do so safely. See your Owner's Manual at [owners.honda.com](http://owners.honda.com) (U.S.) for further license and warranty terms.

## Models with Display Audio

## FM/AM Radio

Play FM or AM radio stations.

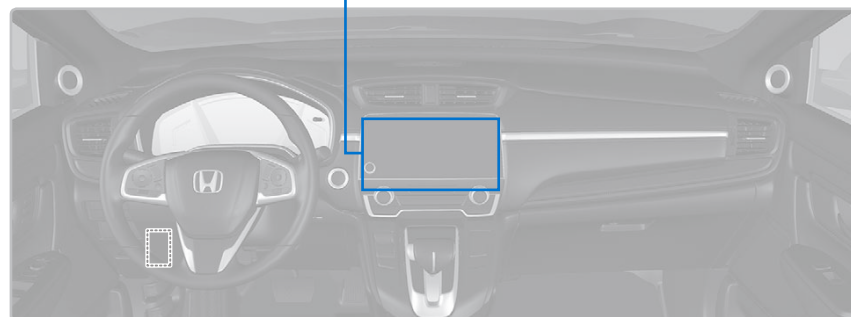
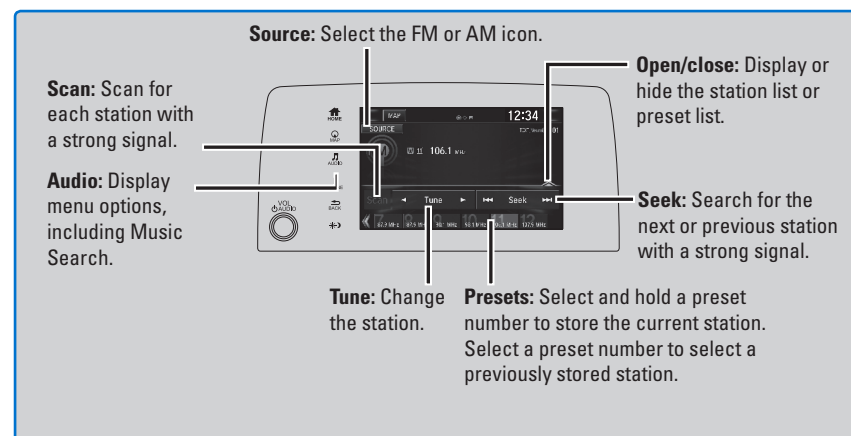

Models with Display Audio

**SiriusXM® Radio\***

Available on a subscription basis only. For more information or to subscribe, contact your dealer, or visit [www.siriusxm.com/subscribenow](http://www.siriusxm.com/subscribenow) (U.S.) or [www.sirius.ca/subscribe-now](http://www.sirius.ca/subscribe-now) (Canada).

**Audio:** Display menu options, including Music Search.

**Scan:** Scan for each station with a strong signal.

**Category:** Change the category.

**Source:** Select the SiriusXM icon.

**Open/close:** Display or hide the channel list or preset list.

**Skip:** Change the selection. Press and hold to skip rapidly.

**Channel:** Change the channel. Press and hold to skip 10 channels at a time.

**Presets:** Select and hold a preset number to store the current station. Select a preset number to select a previously stored station.

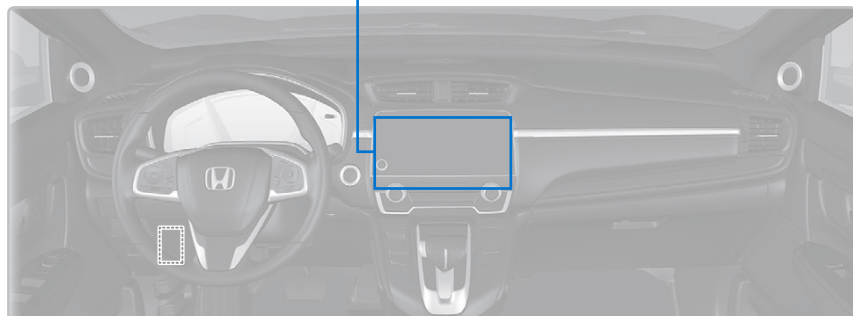

To learn about additional features—such as multi-channel preset, replay, or SportsFlash—see your Owner’s Manual at [owners.honda.com](http://owners.honda.com).

Available in the U.S. and Canada, except Hawaii, Alaska, and Puerto Rico. XM® is a registered trademark of Sirius XM Radio, Inc.

\*if equipped

Models with Display Audio

**iPod®**

Play and operate an iPod through the vehicle’s audio system. Connect your device to the USB port (see page 62).

If an iPhone is connected via Apple CarPlay (see page 75), the iPod source is unavailable and audio files on the phone can only be played within Apple CarPlay.

**Audio:** Display menu options, including Music Search.

**Play/pause**

**Source:** Select the iPod icon.

**Open/close:** Display or hide the track list.

**Song:** Change the track. Press and hold to move rapidly within a track.

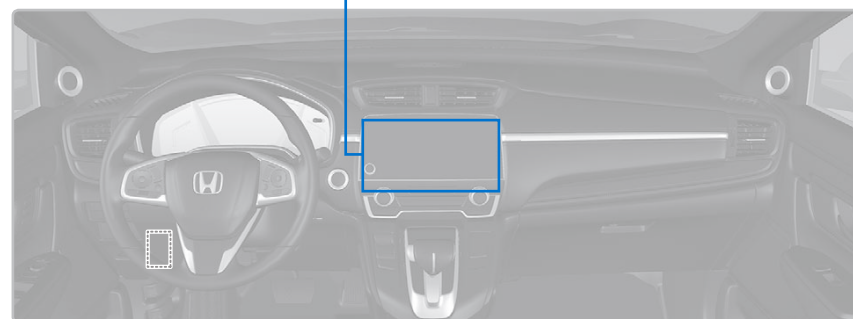

■ **Searching for Music**

Use the touchscreen to search for tracks stored on the iPod.

1. From the audio screen, press MENU.
2. Select Music Search.
3. Select a search option.
4. Select the track you want to play.
5. On vehicles with navigation, you can also search for and play iPod music using Song By Voice (see page 167).

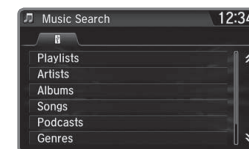

iPod is a trademark of Apple, Inc.

Models with Display Audio

**USB Flash Drive**

Play and operate a USB flash drive through the vehicle's audio system. Connect your device to the USB port (see page 62).

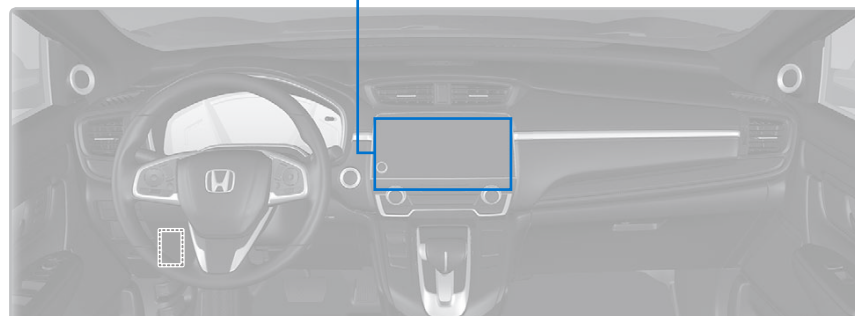
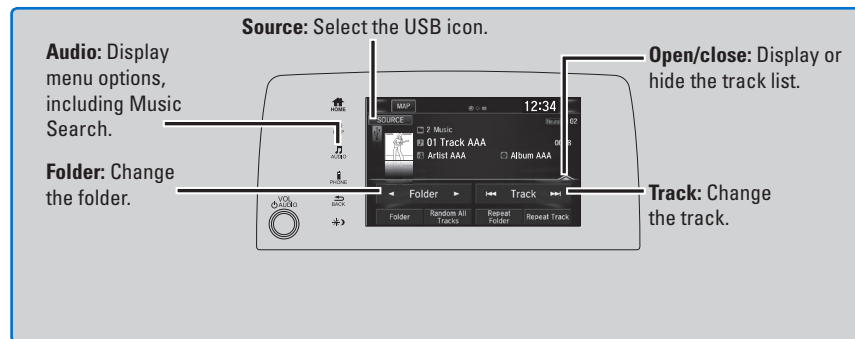

■ **Searching for Music**

Use the touchscreen to search for tracks stored on the USB flash drive.

1. From the audio screen, press MENU.
2. Select Music Search.
3. Select a folder.
4. Select the track you want to play.

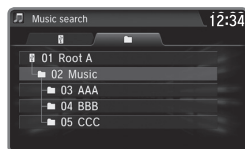

On vehicles with navigation, you can also search for and play music from the flash drive using Song By Voice (see page 167).

Models with Display Audio

**Bluetooth® Audio**

Play streaming or stored audio from your compatible phone through the vehicle's audio system. Visit [automobiles.honda.com/handsfreelink/](http://automobiles.honda.com/handsfreelink/) (U.S.) or phone (888) 528-7876 (U.S. and Canada) to check phone compatibility. Standard data rates apply with your phone service provider. Connect your phone to *Bluetooth* HandsFreeLink (see page 88).

If a phone is currently connected via Apple CarPlay (see page 75) or Android Auto (see page 76), *Bluetooth* Audio from that phone is unavailable.

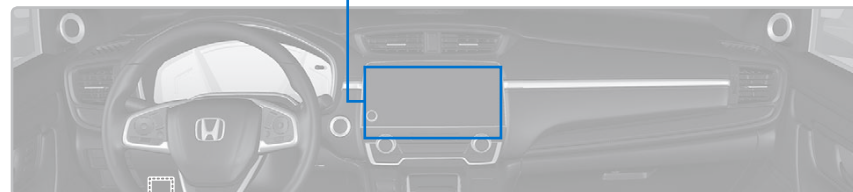
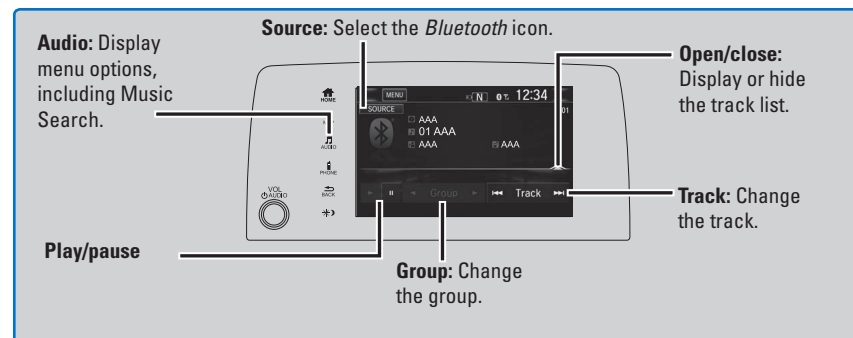

■ **Searching for Music**

Use the touchscreen to search for tracks stored on the device.

1. From the audio screen, press MENU.
2. Select Music Search.
3. Select a search category.
4. Select the track you want to play.

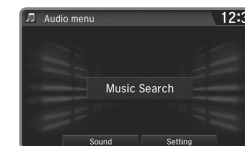

**Notes:**

- Make sure the volume on your phone is properly adjusted.
- You may need to enable additional settings on your phone for playback.
- Certain audio controls are not supported on all phones.

*Applicable laws may prohibit the operation of handheld electronic devices while operating a vehicle. Launch streaming audio on your phone only when safe to do so.*



Models with Display Audio

**Pandora®\***

Play and operate Pandora from your compatible phone through the vehicle's audio system. Visit [automobiles.honda.com/handsfreelink/](http://automobiles.honda.com/handsfreelink/) or phone (888) 528-7876 to check phone compatibility. Standard data rates apply with your phone service provider.

Connect your phone when the vehicle is stopped. Disruptions in your phone's cell signal can affect audio playback.

**For iPhone:**

- Connect via *Bluetooth* HandsFreeLink (see page 88) or USB port (see page 62).
- A pop-up may appear on your phone requesting you to allow access for Pandora to be launched.
- If you cannot operate Pandora through the audio system, it may be streaming through *Bluetooth* Audio. Make sure Pandora is selected on the audio system.
- If Pandora still does not operate, try rebooting the phone and reconnecting the cable if necessary.

**For other compatible smartphones:**

- Connect via *Bluetooth* HandsFreeLink (see page 88).
- If your phone is connected to Android Auto (see page 76), Pandora is only available through the Android Auto interface. Visit the Android Auto website to check compatibility.

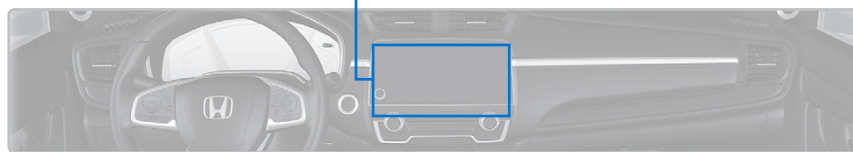
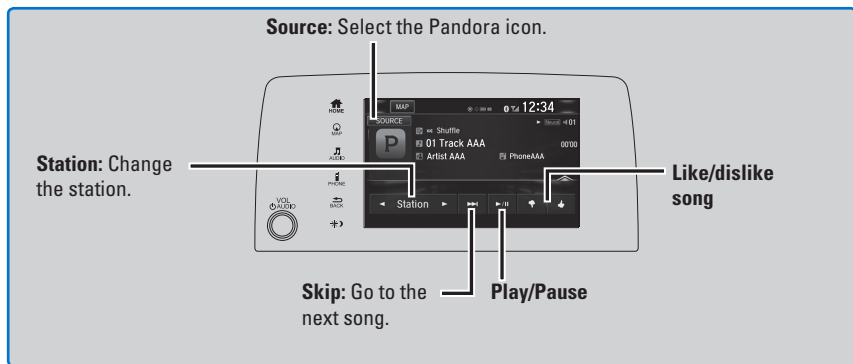

**BLUETOOTH HANDSFREELINK® (HFL)**

Learn how to operate the vehicle's hands-free calling system.

**Models with color audio system**

**Basic HFL Operation**

Make and receive phone calls using the vehicle's audio system, without handling your phone. Visit [automobiles.honda.com/handsfreelink/](http://automobiles.honda.com/handsfreelink/) (U.S.) or phone (888) 528-7876 (U.S. and Canada) to check phone compatibility.

**To reduce the potential for driver distraction, certain manual functions may be inoperable or grayed out while the vehicle is moving. Stop or pull over to perform the function.**

■ **HFL Controls**

Use the controls to enter information and make selections.

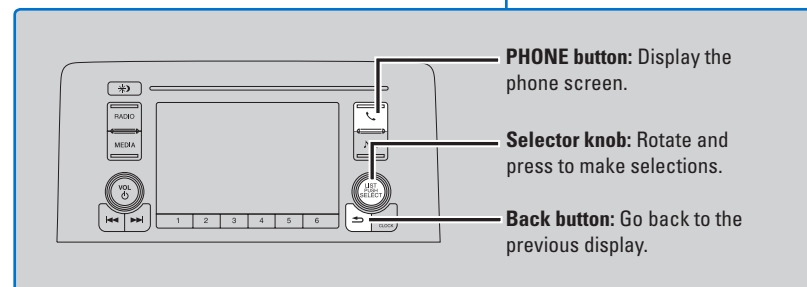
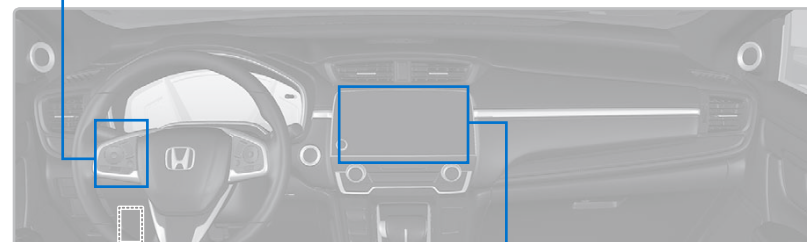
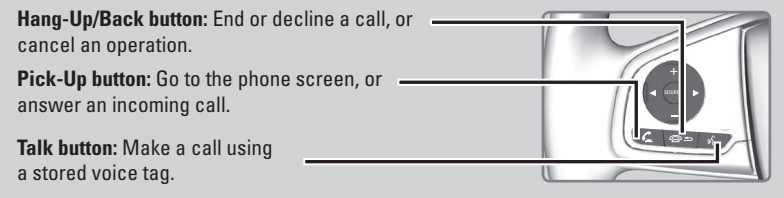

*\*If equipped  
Applicable laws may prohibit the operation of handheld electronic devices while operating a vehicle. Launch streaming audio on your phone only when safe to do so.*

## Models with color audio system

## Pairing a Phone

To use hands-free phone and streaming audio functions, you must first pair your phone to the system. This can only be done when the vehicle is stopped. Use the selector knob to make and enter selections.

## ■ Pairing the First Phone

1. Press the Phone button to go to the Phone screen. A prompt appears. Select Yes.
2. Make sure your phone is in discovery mode. Select OK.
3. The system searches for your phone. Select your phone when it appears on the list.  
*If your phone does not appear:* Select Phone Not Found? and search for HandsFreeLink from your phone. Connect to HFL.
4. The system gives you a pairing code. Compare it to the code that appears on your phone. Connect to HFL from your phone.

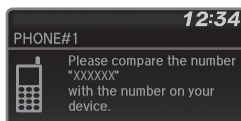
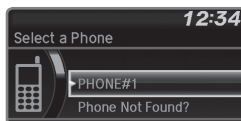
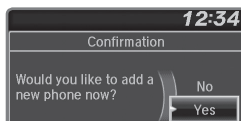

## ■ Pairing an Additional Phone

1. Press the Phone button to go to the Phone screen. If a prompt appears asking to connect to a phone, select No.
2. Select Phone Setup.
3. Select Bluetooth Setup.
4. Select Add New Device.
5. Make sure your phone is in discovery mode. Select OK.
6. The system searches for your phone. Select it when it appears on the list.  
*If your phone does not appear:* Select Phone Not Found?, and search for HandsFreeLink from your phone. Connect to HFL.
7. The system gives you a pairing code. Enter it on your phone when prompted.

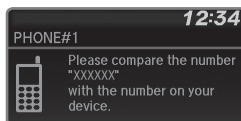

*Applicable laws may prohibit the operation of handheld electronic devices while operating a vehicle.*

## Models with color audio system

## Making a Call

You can make a call using several methods.

## ■ Dialing a Number

Enter a 10-digit phone number to call. Use the selector knob to make and enter selections. This method is inoperable while the vehicle is moving.

1. Press the Phone button.
2. Select Dial.
3. Enter the phone number. Select the green phone icon to call.



## ■ Using the Phonebook

When your phone is paired, its phonebook is automatically imported to the system. Use the selector knob to make and enter selections. This method is inoperable while the vehicle is moving.

1. Press the Phone button.
2. Select Phonebook.
3. Scroll through the list to find the name and number you want to call, and select it to call.



## ■ Storing Speed Dial Entries

Store up to 20 numbers for quick dialing. Use the selector knob to make and enter selections.

1. Press the Phone button.
2. Select Speed Dial, then select Add New.
3. Select an entry method.
4. If desired, you can create a voice tag for the number. Follow the prompts.



## ■ Using Speed Dial

Make calls quickly using stored speed dial entries. Use the selector knob to make and enter selections.

1. Press the Phone button.
2. Select Speed Dial.
3. Scroll through the list to find the entry you want to call, and select it to call.



Speed dial entries with stored voice tags can be called using the Talk button. Press the Talk button and follow the prompts.



## Models with Display Audio

### Basic HFL Operation

Make and receive phone calls using the vehicle's audio system, without handling your phone. Visit [automobiles.honda.com/handsfreelink/](http://automobiles.honda.com/handsfreelink/) (U.S.) or phone (888) 528-7876 (U.S. and Canada) to check phone compatibility.

**To reduce the potential for driver distraction, certain manual functions may be inoperable or grayed out while the vehicle is moving. Stop or pull over to perform the function. Voice commands are also available.**

#### ■ HFL Controls

Use the controls to enter information and make selections.

**Hang-Up/Back button:** End or decline a call, or cancel an operation.

**Pick-Up button:** Answer an incoming call.

**Talk button:** Make a call using a stored voice tag, or say voice commands\*.

**📞 button:** Press until the phone screen is displayed in the Driver Information Interface.

**▲ / ▼ buttons:** Scroll the phone list in the Driver Information Interface.

**ENTER button:** From the phone screen in the Driver Information Interface, select from Speed Dial, Call History, or Phonebook.

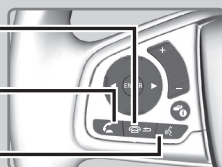

**Phone:** From the HOME screen, display the phone screen.

**BACK:** Go back to the previous display.

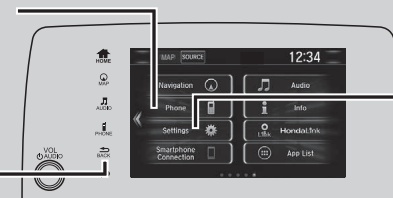

Models with Navigation shown

**Settings:** Select Phone from the Settings screen for phone pairing and more.

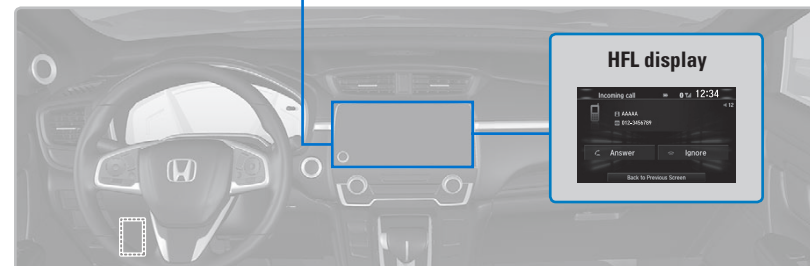

#### ■ Talk Button Tips

For a list of available phone commands, see page 166. The system recognizes only the commands on the list.

- When using the Talk button, wait until you hear a beep before speaking.
- To bypass the system prompts, simply press the Talk button again to say your command.\*
- When the Talk button is pressed, all available voice commands are highlighted in yellow.\*
- Speak in a clear, natural voice.
- Reduce all background noise.
- Adjust the dashboard vents away from the microphone on the ceiling.
- Close the windows and moonroof.

## Models with Display Audio

## Pairing a Phone

To use hands-free phone and streaming audio functions, you must first pair your phone to the system. This can only be done when the vehicle is stopped. Use the touchscreen to make and enter selections.

If there is an active connection to Apple CarPlay (see page 75) or Android Auto (see page 76), pairing of additional *Bluetooth*-compatible devices is unavailable and Add Bluetooth Device is grayed out from the Bluetooth Device List screen.

1. From the Home screen, select Settings.
2. Select Phone, then select Yes.
3. Make sure your phone is in discovery mode. Select Continue.
4. The system searches for your phone. Select your phone when it appears on the list.
5. If your phone does not appear: Select Refresh or Select Phone Not Found and search for Bluetooth® devices using your phone. From your phone, search for HandsFreeLink.
6. The system gives you a pairing code. Confirm the code that appears on the screen and your phone match. Connect to HFL from your phone.

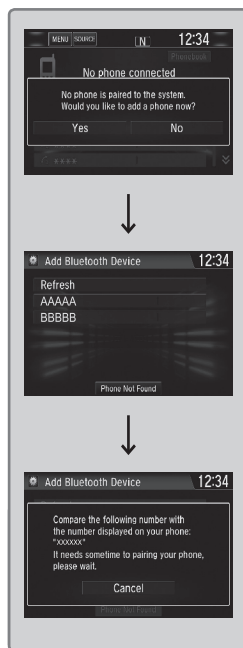

*Applicable laws may prohibit the operation of handheld electronic devices while operating a vehicle.*

## Models with Display Audio

## Making a Call

You can make a call using several methods.

### ■ Dialing a Number

Enter a 10-digit phone number to call.

#### Using voice commands

Press the Talk button before you say each command.

1. Say "Dial by number."
2. Say the phone number: For example, "3-1-0-5-5-1-2-3-4."
3. The system begins to dial.

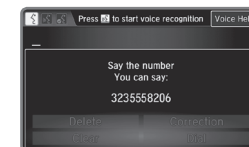

#### Using the touchscreen

Manual operation is limited while the vehicle is moving. Voice commands are always available.

1. From the Home screen, select Phone.
2. Select MENU.
3. Select Dial.
4. Enter the phone number. Select the green phone icon to call.

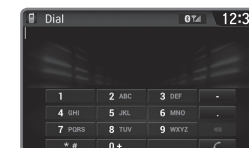

### ■ Using the Phonebook

When your phone is paired, its entire phonebook can be automatically imported to the system. Phone synchronization must be turned on.

#### Using voice commands

Press the Talk button before you say each command.

1. Say "Dial by name."
2. Say the phonebook name and phone type. For example, "John Smith mobile."

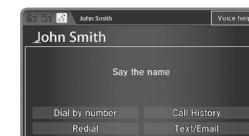

#### Using the touchscreen

Manual operation is limited while the vehicle is moving. Voice commands are always available.

1. From the Home screen, select Phone.
2. Select MENU.
3. Select Phonebook.
4. Scroll through the list to find the name and number you want to call, and select it to call.

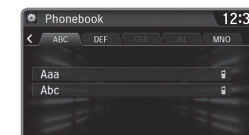

## ■ Storing Speed Dial Entries

Store up to 20 numbers for quick dialing.

1. From the Home screen, select Phone.
2. Select MENU.
3. Select Edit Speed Dial, then select New Entry.
4. Select an entry method.
5. If desired, you can create a voice tag for the number. Follow the prompts.



## ■ Using Speed Dial

Make calls quickly using stored speed dial entries.

### Using voice commands

Press the Talk button before you say each command.

1. Say "Dial by name."
2. Say the stored voice tag name. For example, "John Smith."



### Using the touchscreen

1. Go to the Phone Menu screen, then select Speed Dial.
2. Scroll through the list to find the entry you want to call, select it to call.



## Models with Display Audio

### SMS Text Messaging and E-Mail\*

Certain phones can receive and send messages when paired and connected. Visit [automobiles.honda.com/handsfreelink/](http://automobiles.honda.com/handsfreelink/) (U.S.) or phone (888) 528-7876 (U.S. and Canada) to check phone compatibility. Standard message rates apply with your phone service provider. This feature is limited while the vehicle is moving.

#### ■ Selecting an Account

If your phone has both text message and e-mail accounts, you can select only one of them at a time to be active and receive notifications.

1. Go to the Phone Settings screen.
  2. Select Text/Email tab.
  3. Select Select Account.
  4. Select a Text Message or an e-mail account.
- To enable new message notification:
5. Return to the Text/Email tab.
  6. Select Enable Text/E-Mail, then select Next.
  7. A pop menu appears, Select On.

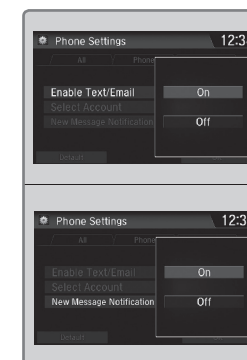

#### ■ Receiving and Responding to Messages

When you receive a new message, a pop-up appears on the touchscreen. You can view the message when the vehicle is stopped. You can also reply to it using fixed phrases or call the sender.

1. When the prompt appears, select Read.
2. The message is displayed, and the system reads it aloud.

*To reply:* With the message open, select Reply, and choose one of the six available responses. Select Send to send the message. You cannot create a new text message.

*To call the sender:* With the message open, select Dial.

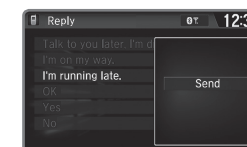
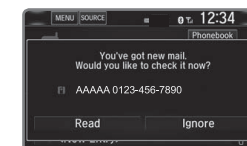

## Models with Display Audio

## Siri® Eyes Free

Activate Siri through your vehicle when an iPhone is paired to the system. Visit [automobiles.honda.com/handsfreelink/](http://automobiles.honda.com/handsfreelink/) (U.S.) or [honda.ca/siri](http://honda.ca/siri) (Canada) to check phone compatibility.

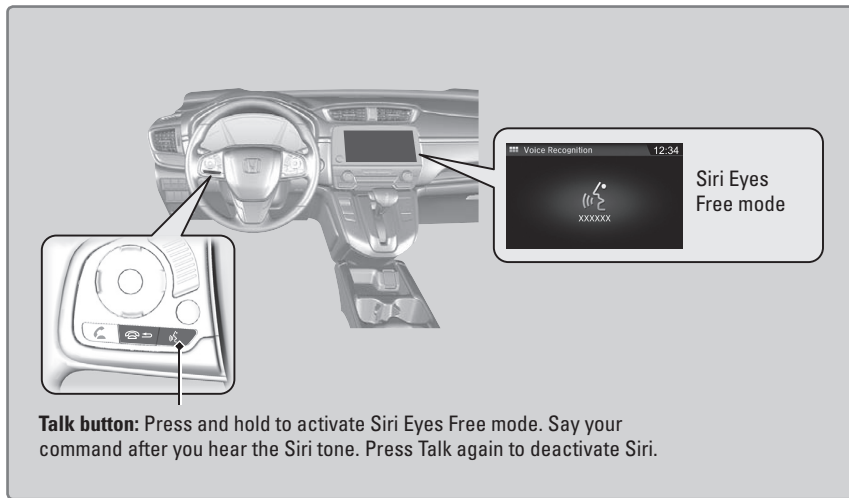

Here are some examples of Siri commands:

*"Call John Smith"*

*"Read my new text message"*

*"Find a nearby sushi restaurant"*

*"Remind me to pick up dinner"*

*"Set up a meeting today at 3 p.m."*

*"Play song XYZ"*

## Notes:

- Any requests that include visual feedback from Siri on your phone are not displayed in the vehicle.
- Certain commands rely on the iPhone's features and existing apps.
- To hear turn-by-turn directions or songs through the vehicle, set the audio source to *Bluetooth Audio*.
- If using Siri Eyes Free through Apple CarPlay (see page 75), use the Talk button to activate and deactivate Siri Eyes Free mode.

*Siri and iPhone are trademarks of Apple, Inc.*

## NAVIGATION\*

Learn how to enter a destination and operate the navigation system.

## Basic Navigation Operation

A real-time navigation system uses GPS and a map database to show your current location and help guide you to a desired destination. You can operate the system using voice commands or the system controls.

**To reduce the potential for driver distraction, certain manual functions may be inoperable or grayed out while the vehicle is moving. Voice commands are always available.**

## Steering Wheel Controls

Use the steering wheel controls to say voice commands.

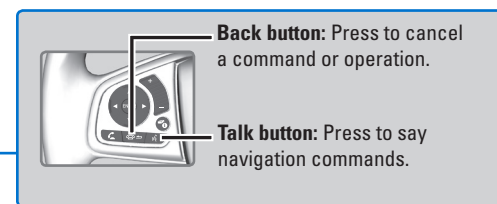
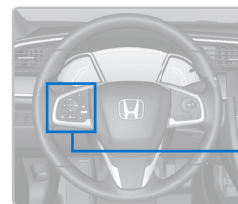

## Talk Button Tips

For a list of available navigation commands, see page 166. The system recognizes only the commands on the list.

- When using the Talk button, wait for a beep before saying a command.
- To bypass the system prompts, simply press the Talk button again to say your command.
- Speak in a clear, natural voice.
- Reduce all background noise.
- Adjust the dashboard vents away from the microphone in the ceiling.
- Close the windows and moonroof.

## System Guidance Volume

Adjust the navigation system volume.

1. From the HOME screen, select Settings.
2. Select System.
3. Select the Sound/Beep tab.
4. Select Guidance Volume and adjust the level.
5. Press BACK to exit the menus.

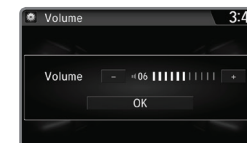

*\*if equipped*

■ **Navigation Display and Controls**

Touch icons on the screen to enter information and make selections.

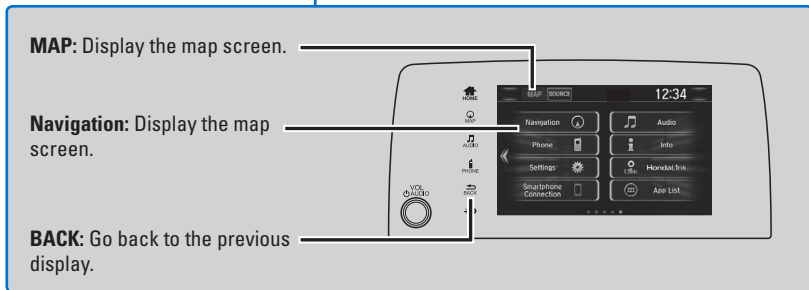
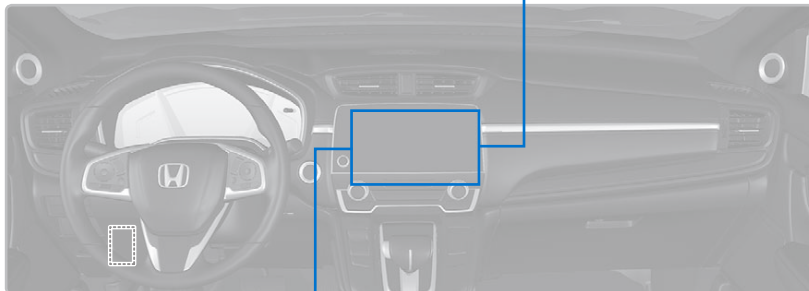
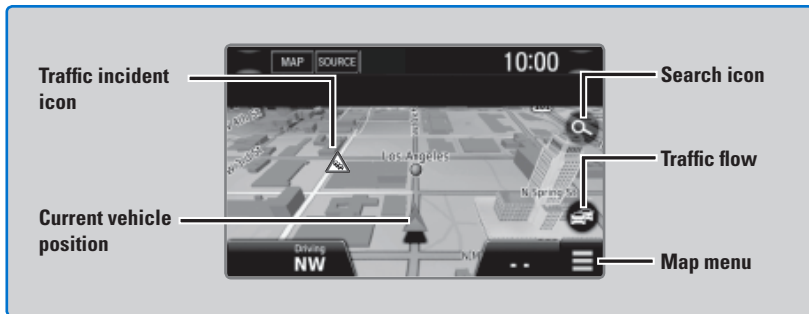

■ **Setting Touchscreen Sensitivity**

You can adjust the touchscreen's sensitivity to your fingertip.

1. From the HOME screen, select Settings, then System.
2. Select Display, then Touch Panel Sensitivity.
3. Make your selection.

**Entering a Destination**

Use several methods to enter a destination.

■ **Home Address**

Store your home address in the system so you can easily route to it.

1. Press the map icon, then select the Search icon.
2. Select MENU.
3. Select Set Home Location.
4. Select Enter My Address.
5. Enter the house number and select Done.
6. Enter the street and select Next.
7. Select the address from the list. A map of the address is shown. Select Select.

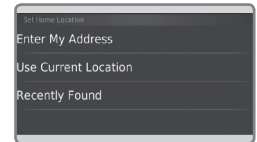
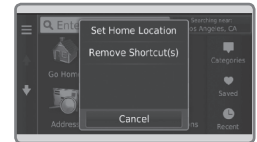

When your home address is stored, you can press the Talk button and say "Navigation" and then "Go home" at any time. You can also select Go Home from the Where To? menu.

■ **Street Address**

Enter a street address.

1. From the map screen, select the Search icon.
2. Select Address.
3. Enter the house number and select Done.
4. Enter the street name and select Done. Select the street from the list.
5. Select the address from the list.
6. Select Go!.

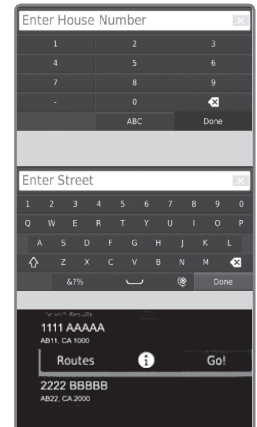

You can also enter a street address using voice commands. Press the Talk button and say "Navigation" and then "Find Address." Follow the prompts.

■ **Place Category**

Enter a destination using a point of interest or landmark.

1. From the map screen, select the Search icon.
2. Select Categories.
3. Select a category (and a subcategory if necessary).
4. Select a place from the list.
5. Select Go!.

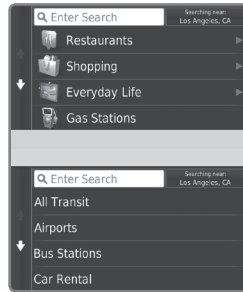

You can also enter a street address using voice commands. Press the Talk button and say "Navigation" and then "Find Place." Follow the prompts.

■ **Recent Places**

Select an address from a list of your 50 most recent destinations.

1. From the map screen, select the Search icon.
2. Select Recent.
3. Select a place from the list.
4. Select Go!.

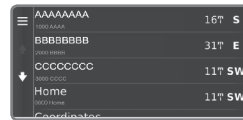

■ **Saved Places**

Save locations so you can quickly route to them.

**Saving a location**

1. From the map screen, select the Search icon.
2. Select Enter Search.
3. Enter the address or place name.
4. Select the destination name when it appears.
5. Select the info icon.
6. Select the menu icon.
7. Select Save.
8. Select OK.

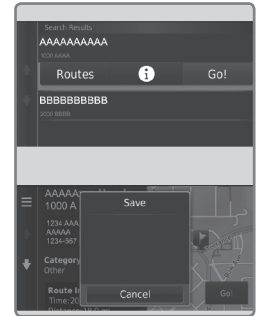

You can also save your current location. From the map screen, select the vehicle icon. Select Save. Enter a name for the location. Select Done. Select OK.

**Routing to a saved location**

1. From the map screen, select the Search icon.
2. Select Saved.
3. Select the destination from the list.
4. Select Go!.

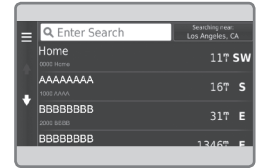

## Routing

After a destination is set, you can alter or cancel your route.

### Map Legend

#### During route guidance

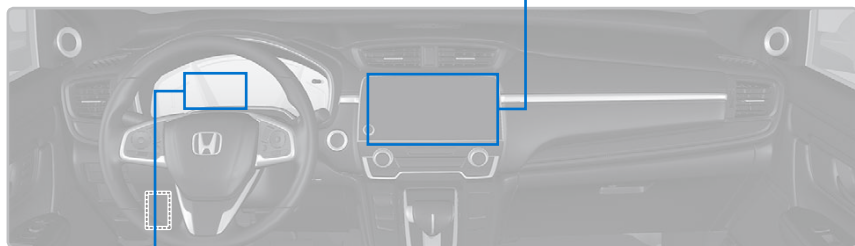

#### Turn-by-turn directions

Shows a more detailed view of the next maneuver on the Driver Information Interface.

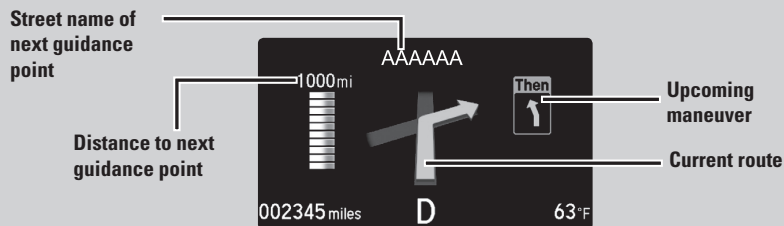

## ⚠ WARNING

Using the navigation system while driving can take your attention away from the road, causing a crash in which you could be seriously injured or killed.

Operate system controls only when the conditions permit you to safely do so.

### Traffic

View traffic flow and incidents in major metro areas. Traffic alerts are accompanied by an audible beep. Pop-up messages and traffic information can be viewed when you are on the map screen. You can also select traffic to avoid. Traffic coverage is limited in Canada.

#### Viewing traffic

1. From the map screen, select the traffic icon.
2. Select Traffic Conditions.
3. Traffic icons are shown on the map. Select the magnifying glass icon to display a full list of traffic delays.

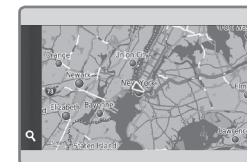

*To mute traffic alerts and voice guidance:* From the map screen, press MENU. Select Mute. To lower voice guidance volume, see page 93.

#### Avoiding traffic on your route

1. From the map screen, select the traffic icon.
2. Select Traffic on Route.
3. Select an incident to avoid from the list.
4. Select the menu icon.
5. Select Avoid.

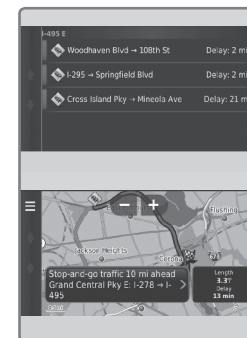



# DRIVING

Learn about preparation for driving, as well as other features.

## Before Driving

Check the following items before you begin driving.

### ■ Exterior Checks

- Make sure there are no obstructions on the windows, door mirrors, exterior lights, or other parts of the vehicle.
- Remove any frost, snow, or ice.
- Make sure the hood is securely closed.
- Heat from the engine and exhaust can ignite flammable materials left under the hood, causing a fire. If you've parked your vehicle for an extended period, inspect and remove any debris that may have collected, such as dried grass and leaves that have fallen or have been carried in for use as a nest by a small animal. Also check under the hood for leftover flammable materials after you or someone else has performed maintenance on your vehicle.
- Make sure the tires are in good condition.
- Make sure there are no people or objects behind or around the vehicle.

### NOTICE

If the doors are frozen shut, use warm water around the door edges to melt any ice. Do not try to force them open, as this can damage the rubber trim around the doors. When done, wipe dry to avoid further freezing.

### ■ Interior Checks

- Store or secure all items on board properly.
- Do not pile items higher than the seat height.
- Do not place anything in the front seat footwells. Make sure to secure the floor mats.
- If you have any animals on board, do not let them move freely around in the vehicle.
- Securely close and lock all doors and the tailgate.
- Adjust your seating position, mirrors, and steering wheel properly.
- Make sure items placed on the floor behind the front seats cannot roll under the seats.
- Everyone in the vehicle must fasten their seat belt.
- Make sure that the indicators in the instrument panel come on when you start the vehicle, and go off soon after.

### ■ Driving Guidelines for Your Utility Vehicle

Utility vehicles have a significantly higher rollover rate than other types of vehicles. To prevent rollovers or loss of control:

- Take corners at slower speeds than you would with a passenger vehicle.
- Avoid sharp turns and abrupt maneuvers whenever possible.
- Do not modify your vehicle in any way that raises its center of gravity.
- Roof load capacity is 165 lbs (75 kg). Available roof racks and carriers may have lower capacities.(Honda Accessory)

In addition:

- During the first 600 miles (1,000 km) of operation, avoid sudden acceleration or full throttle operation so as not to damage the engine or powertrain.
- Avoid hard braking for the first 200 miles (300 km). You should also follow this when the brake pads are replaced.

### ⚠ WARNING

Improper accessories or modifications can affect your vehicle's handling, and stability, and performance, and cause a crash in which you can be seriously hurt or killed.

Follow all instructions in the vehicle owner's manual regarding accessories and modifications.

Your vehicle has been designed primarily for use on pavement; however, its higher ground clearance allows you to occasionally travel on unpaved roads. It is not designed for trail-blazing or other challenging off-road activities.

If you decide to drive on unpaved roads, you will find that it requires somewhat different driving skills and that your vehicle will handle somewhat differently than it does on pavement. Pay attention to the precautions and tips in this section, and get acquainted with your vehicle before leaving the pavement.

### ⚠ WARNING

Improperly operating this vehicle on or off pavement can cause a crash or rollover in which you and your passengers can be seriously hurt or killed.

Follow all instructions and guidelines in this guide.

Keep your speed low, and don't drive faster than conditions permit.

## Maximum Load Limit

Carrying too much cargo or improperly storing it can affect your vehicle's handling, stability, stopping distance, and tires, and make it unsafe.

The maximum load for your vehicle is 850 lbs (385 kg). See the Tire and Loading Information label attached to the driver's doorjamb.

Label example

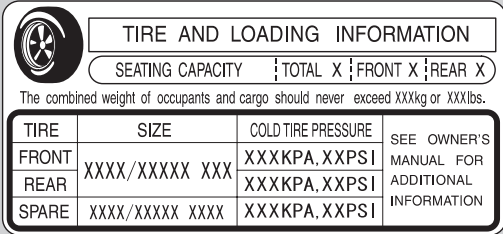

**TIRE AND LOADING INFORMATION**

SEATING CAPACITY: TOTAL X, FRONT X, REAR X

The combined weight of occupants and cargo should never exceed XXXkg or XXXlbs.

TIRE	SIZE	COLD TIRE PRESSURE	SEE OWNER'S MANUAL FOR ADDITIONAL INFORMATION
FRONT	XXXX/XXXX XXX	XXXKPA, XXPSI	
REAR	XXXX/XXXX XXX	XXXKPA, XXPSI	
SPARE	XXXX/XXXX XXX	XXXKPA, XXPSI	

This figure includes the total weight of all occupants, cargo, and accessories, and the tongue load if you are towing a trailer. Below are the steps for determining the correct load limit:

1. Locate the statement "The combined weight of occupants and cargo should never exceed XXX kg or XXX lbs." on your vehicle's placard.
2. Determine the combined weight of the driver and passengers that will be riding in your vehicle.
3. Subtract the combined weight of the driver and passengers from XXX kg or XXX lbs.
4. The resulting figure equals the available amount of cargo and luggage load capacity. For example, if the "XXX" amount equals 1,400 lbs. and there will be five 150 lb. passengers in your vehicle, the amount of available cargo and luggage load capacity is 650 lbs. (1,400 - 750 (5 x 150) = 650 lbs.)
5. Determine the combined weight of luggage and cargo being loaded on the vehicle. That weight may not safely exceed the available cargo and luggage load capacity calculated in step 4.
6. If your vehicle will be towing a trailer, load from your trailer will be transferred to your vehicle. Consult the Owner's Manual to determine how this reduces the available cargo and luggage load capacity of your vehicle.

In addition, the total weight of the vehicle, all occupants, accessories, cargo, and trailer tongue load must not exceed the Gross Vehicle Weight Rating (GVWR) or the Gross Axle Weight Rating (GAWR). Both are on a label on the driver's doorjamb.

### Load Limits Example

Example1



Max Load  
850 lbs  
(385 kg)

≥



Passenger Weight  
150 lbs x 2 = 300 lbs  
(68 kg x 2 = 136 kg)

+



Cargo Weight  
550 lbs  
(249 kg)

  

Example2



Max Load  
850 lbs  
(385 kg)

≥



Passenger Weight  
150 lbs x 5 = 750 lbs  
(68 kg x 5 = 340 kg)

+



Cargo Weight  
100 lbs  
(45 kg)

### ⚠ WARNING

Overloading or improper loading can affect handling and stability and cause a crash in which you can be hurt or killed.

Follow all load limits and other loading guidelines in this guide.

The headlight aim on your vehicle was set by the factory, and does not need to be adjusted. However, if you regularly carry heavy items in the cargo area or pull a trailer, have the aiming readjusted at your dealer or by a qualified technician.

### Improving Fuel Economy and Reducing CO<sub>2</sub> Emissions

Achieving fuel economy and reducing CO<sub>2</sub> emissions is dependent on several factors, including driving conditions, load weight, idling time, driving habits, and vehicle condition. Depending on these and other factors, you may not achieve the rated fuel economy of this vehicle.

### Towing Your Vehicle

This vehicle is not designed to be towed behind a motorhome. Doing so may damage the transmission.

## Towing a Trailer

Your vehicle can tow a trailer if you carefully observe the load limits, use the proper equipment, and follow the towing guidelines. See the Owner's Manual at [owners.honda.com](http://owners.honda.com) for more information.

### ■ Towing Load Limits

#### Total trailer weight

Maximum allowable weight of the trailer, cargo, and everything in or on it must not exceed 1,500 lbs (680 kg). Towing loads in excess of this can seriously affect vehicle handling and performance and can damage the engine and drivetrain.

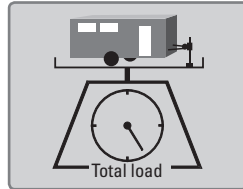

#### Tongue load

The weight of the tongue with a fully loaded trailer on the hitch should be approximately 10% of the total trailer weight.

- Excessive tongue load reduces front tire traction and steering control. Too little tongue load can make the trailer unstable and cause it to sway.
- To achieve a proper tongue load, start by loading 60% of the load toward the front of the trailer and 40% toward the rear. Readjust the load as needed.

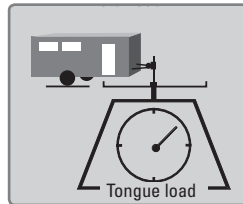

#### Pre-tow checklist

When preparing to tow, and before driving away, ensure the following:

- The vehicle has been properly serviced, and the suspension and the cooling system are in good operating condition.
- Avoid towing a trailer during your vehicle's first 600 miles (1,000 km).
- The trailer has been properly serviced and is in good condition.
- All weights and loads are within limits. Never exceed the gross weight ratings.
- Check if all loads are within limits at a public scale. If a public scale is not available, add the estimated weight of your cargo load to the weight of your trailer (as quoted by the manufacturer) and the tongue load.
- The hitch, safety chains, and any other attachments are secure.
- All items in or on the trailer are properly secured and cannot shift while you drive.

### ⚠ WARNING

Exceeding any load limit or improperly loading your vehicle and trailer can cause a crash in which you can be seriously hurt or killed.

Check the loading of your vehicle and trailer carefully before starting to drive.

## Remote Engine Start with Vehicle Feedback\*

Start your vehicle's engine using the remote transmitter before you enter the vehicle.

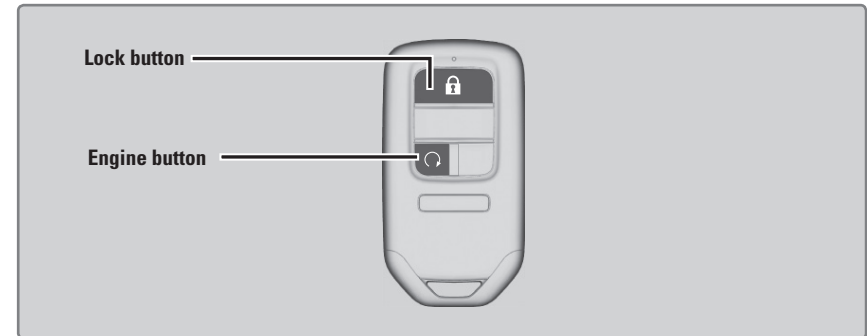

Make sure the vehicle is in a safe location when using remote engine start (i.e., a well ventilated area, away from any flammable materials).

### ■ Starting the Engine

Press the Lock button, then press and hold the Engine button within 5 seconds to remotely start the engine.

The engine runs for up to 10 minutes. To extend the run time for another 10 minutes, repeat the procedure during the initial 10 minutes.

While the engine is running, the climate control system adjusts the cabin temperature, the security system remains on, and lights and accessories remain off.

### ■ Stopping the Engine

Press and hold the Engine button.

The engine will also stop if it has been running for more than 10 minutes, or if any door is opened without using the remote or smart entry.

### ⚠ WARNING

Engine exhaust contains toxic carbon monoxide gas.

Breathing carbon monoxide can kill you or cause unconsciousness.

Never use the remote engine starter when the vehicle is parked in a garage or other area with limited ventilation.

## Starting to Drive

Turn on the vehicle and start the engine to begin driving.

### ■ Before Starting the Engine

Check that the shift lever is in Park (P), then press the brake pedal. Keep your foot firmly on the brake pedal when starting the engine.

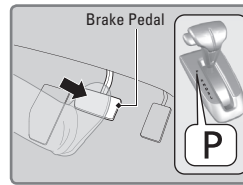

The engine is harder to start in cold weather and in thinner air found at altitudes above 8,000 feet (2,400 m). When starting the engine in cold weather, turn off all electrical accessories such as the lights, climate control system, and rear defogger in order to reduce battery drain.

### ■ Starting the Ignition\*

Insert the key into the ignition and turn to turn on the vehicle or start the engine.

- Ⓚ **LOCK:** Insert and remove the key in this position.
- Ⓛ **ACCESSORY:** Operate the audio system and other accessories in this position.
- Ⓜ **ON:** This is the position when driving.
- Ⓝ **START:** This position is for starting the engine. The switch returns to ON when you release the key.

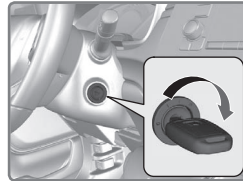

### ■ Changing the Power Mode\*

Use the ENGINE START/STOP button to cycle through power modes or start the engine.

**Accessory or On mode:** Press ENGINE START/STOP once without pressing the brake pedal for Accessory mode. Press it again for On mode.

**Starting the engine:** Press and hold the brake pedal, then press ENGINE START/STOP. Keep your foot firmly on the brake pedal when starting the engine.

**Turning the vehicle off:** Shift to Park (P), then press ENGINE START/STOP.

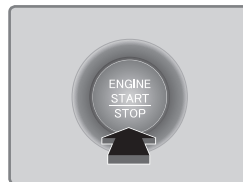

### ■ Shifting

Change the shift position based on your driving needs.

**Park (P):** Used for parking or starting/stopping the engine. Press the brake pedal, then press the release button to shift.

**Reverse (R):** Used for reversing.

**Neutral (N):** Used for idling.

**Drive (D):** Used for normal driving.

**Drive (S):** Used for better acceleration, increased engine braking, or driving in hilly terrain.

**Low (L):** Used for stronger engine braking when driving in hilly terrain.

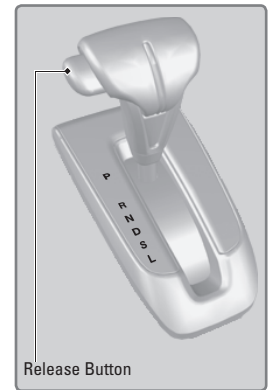

### NOTICE

When you change the shift lever from D to R and vice versa, come to a complete stop and keep the brake pedal depressed. Operating the shift lever before the vehicle has come to a complete standstill can damage the transmission.

Do not operate the shift lever while pressing the accelerator pedal. You could damage the transmission.

## Braking

Slow down or stop your vehicle, and keep it from moving when parked.

### ■ Foot Brake

Press the brake pedal to slow down or stop your vehicle from moving.

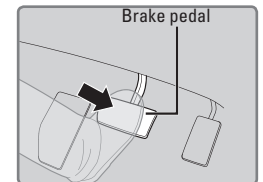

### ■ Electric Parking Brake

**To apply:** Pull up the switch. The parking brake indicator appears in the instrument panel. Hold the switch up for emergency braking while moving.

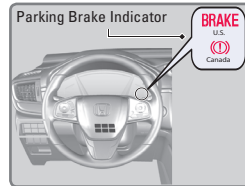
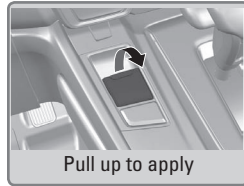

**To release:** Hold the brake pedal down and make sure your seat belt is fastened. Press the switch down to release. The parking brake indicator disappears from the instrument panel.



**To release automatically:** Lightly press the accelerator pedal after you have turned the vehicle on, fastened your seat belt, and changed the shift position to either Drive (D) or Reverse (R).

*If the parking brake does not release automatically, simply release it manually.*

### ■ Brake Assist System

During hard or emergency braking, the system increases braking force. The brake pedal may move slightly or make a noise; this is normal. Continue to hold the brake pedal firmly down.

### ■ Hill Start Assist System

When you're stopped on a hill, hill start assist helps prevent the vehicle from rolling while you move your foot from the brake to the accelerator.

### ■ Anti-Lock Brake System (ABS)

During hard or emergency braking, the system rapidly pumps the brakes to prevent wheel lockup and help you maintain steering control. Do not pump the brake pedal, rather continue to hold it firmly down.

When ABS activates, you may notice vibrations through the brake pedal or the vehicle body, the brake pedal depressing further than usual, or hear a motor noise from the engine compartment. These are all normal.

In normal use, the ABS system will occasionally cause a motor sound from the engine compartment, especially when the engine is first started or after repeated use of the brakes.

### NOTICE

The ABS may not function correctly if you use an incorrect tire type and size.

### ■ Automatic Brake Hold

Maintains rear brake hold even after the brake pedal is released. Make sure the vehicle is on and your seat belt is fastened when operating this feature.

1. Press the BRAKE HOLD button behind the shift lever. The BRAKE HOLD indicator appears in the instrument panel.
2. With the shift lever in Drive (D) or Neutral (N), press the brake pedal and come to a complete stop. The HOLD indicator appears, and brake hold is applied. Release the brake pedal.



Press the accelerator pedal to cancel brake hold and start moving.

**To turn off brake hold:** Press the brake pedal and press the BRAKE HOLD button again.

Automatic brake hold cancels when:

- Braking is applied for more than 10 minutes.
- The electric parking brake is engaged.
- The foot brake is pressed and the shift lever is moved to Park (P) or Reverse (R).
- The driver's seat belt is unfastened.
- The engine is turned off.
- There is a problem with the automatic brake hold system.

### ⚠ WARNING

Activating the automatic brake hold system on steep hills or slippery roads may still allow the vehicle to move if you remove your foot from the brake pedal.

If a vehicle unexpectedly moves, it may cause a crash resulting in serious injury or death.

Never use the automatic brake hold system or rely on it to keep a vehicle from moving when stopped on a steep hill or slippery roads.

### ⚠ WARNING

Using the automatic brake hold system to park the vehicle may result in the vehicle unexpectedly moving.

If a vehicle moves unexpectedly, it may cause a crash, resulting in serious injury or death.

Never leave the vehicle when braking is temporarily kept by automatic brake hold and always park the vehicle by putting the transmission in Park (P) and applying the parking brake.

## Vehicle Stability Assist (VSA®)

Also known as Electronic Stability Control (ESC), VSA helps to stabilize the vehicle during cornering if the vehicle turns more or less than what was intended. It assists in maintaining traction on slippery surfaces by regulating engine output and selectively applying the brakes.

### ■ Turning VSA On or Off

VSA is turned on every time you start the engine, even if you previously turned it off. If you turn VSA off, your vehicle has normal braking and cornering ability, but not VSA traction and stability enhancement.

Press and hold the VSA OFF button until you hear a beep to turn VSA on or off. The VSA OFF indicator appears when the system is off.

Traction control stops functioning, which may make it easier when trying to free your vehicle if it is stuck in mud or snow.

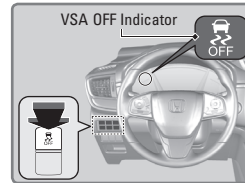

## Eco Assist™ System

Can help improve fuel economy by adjusting the performance of the engine, transmission, climate control system, and cruise control.

### ■ ECON Button

Press the ECON button to turn the system on or off. The ECON Mode indicator appears when the system is turned on.

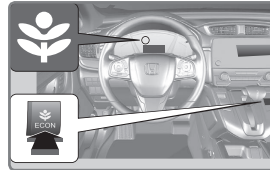

### ■ Ambient Meter

Color-coded bars around the speedometer change based on your driving style and brake or accelerator pedal operation.

**Green:** Fuel efficient driving

**Light green:** Moderate acceleration/deceleration

**White:** Spirited acceleration/deceleration



## Cruise Control\*

Maintain a constant vehicle speed without having to keep your foot on the accelerator pedal. Use cruise control on highways or open roads where you can travel at a constant speed with little acceleration or deceleration.

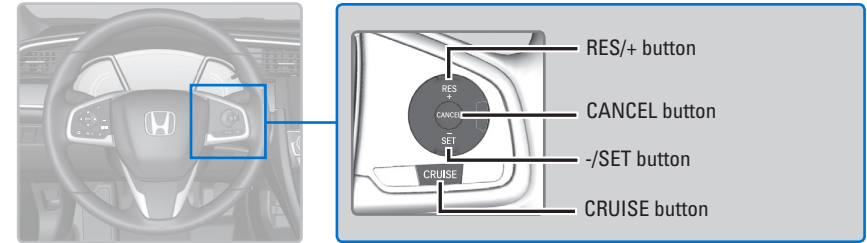

### ■ Activating and Setting the Vehicle Speed

1. Press the CRUISE button. The CRUISE MAIN indicator appears.
2. Accelerate to the desired speed (above 25 mph/40 km/h). Take your foot off the pedal and press the -/SET button to set the speed. The CRUISE CONTROL indicator appears.



### ■ Adjusting the Vehicle Speed

Press the RES/+ button to increase speed, or the -/SET button to decrease speed.

Each time you press the button, the vehicle speed is increased or decreased by about 1 mph (1.6 km/h). If you keep the button pressed, the vehicle speed increases or decreases until you release it.

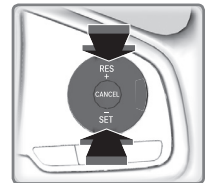

### ■ Canceling Cruise Control

Press the CANCEL or CRUISE buttons, or the brake pedal. The CRUISE CONTROL indicator goes off.

After cruise control has been canceled, you can still resume the prior set speed by pressing RES/+ while driving at a speed of at least 25 mph (40 km/h).

Press the CRUISE button to turn the system off.

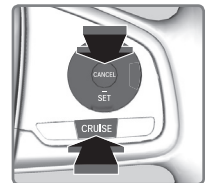

## ⚠ WARNING

Improper use of cruise control can lead to a crash.

Use cruise control only when traveling on open highways in good weather.



## Honda Sensing™\*

Honda Sensing is a driver support system which employs the use of two distinctly different kinds of sensors, a radar sensor located at the lower part of the front bumper and a front sensor camera mounted to the interior side of the windshield, behind the rear view mirror. These are the components of Honda Sensing:

**Adaptive Cruise Control (ACC) with Low Speed Follow (LSF)\*:** Helps maintain a constant vehicle speed and a set following interval behind a vehicle detected ahead of yours and, if the detected vehicle comes to a stop, can decelerate and stop your vehicle (see page 113).

**Lane Keeping Assist System (LKAS):** Provides steering input to help keep the vehicle in the middle of a detected lane and provides tactile and visual alerts if the vehicle is detected drifting out of its lane (see page 117).

**Road Departure Mitigation (RDM) System:** Alerts and helps to assist you when the system detects a possibility of your vehicle unintentionally crossing over detected lane markings and/or leaving the roadway altogether (see page 118).

**Collision Mitigation Braking System (CMBS):** Can assist you when there is a possibility of your vehicle colliding with a vehicle or a pedestrian detected in front of yours (see page 119).

## Adaptive Cruise Control (ACC) with Low Speed Follow (LSF)\*

Helps maintain a constant vehicle speed and a set following interval behind a vehicle detected ahead of yours.

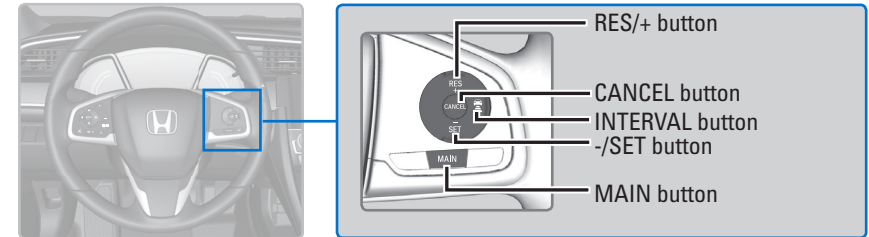

### ■ Activating and Setting the Vehicle Speed

1. Press the MAIN button. The ACC indicator appears.
2. Accelerate to the desired speed.  
*Above 25 mph (40 km/h):* Take your foot off the pedal and press the -/SET button to set the speed  
*Below 25 mph (40 km/h) (Low Speed Follow):* Press the -/SET button to set the speed at 25 mph (40 km/h) if a vehicle is detected in front of you.



### ■ Adjusting the Vehicle Speed

Press the RES/+ button to increase speed, or the -/SET button to decrease speed.

Each time you press the switch up or down, the vehicle speed is increased or decreased by about 1 mph or 1 km/h. If you keep the switch pressed up or down, the vehicle speed increases or decreases by 5 mph or 5 km/h until you release it.



\*if equipped



### ■ Adjusting the Following Interval

Press the INTERVAL button to change the following interval. Each time you press the button, the following-interval setting cycles through short, middle, long, and extra long.

Interval	Short	Middle	Long	Extra Long
Approx. Gap (seconds)	1.1	1.5	2.1	2.8



### ■ Switching to Standard Cruise Control

Press and hold the Interval button.

Cruise mode appears in the Driver Information Interface. Press and hold the button again to switch back to ACC.

### ■ Turning off ACC

Press the MAIN button to turn off ACC. The ACC indicator will shut off.

### ■ When in Operation

If a vehicle is detected ahead of you when ACC is turned on, the system maintains, accelerates, or decelerates your vehicle's set speed to keep the vehicle's set following interval from the vehicle ahead.

If a vehicle detected ahead of you slows down abruptly, or if another vehicle cuts in front of you, a beep sounds and BRAKE appears on the Driver Information Interface to alert you.

When a vehicle detected ahead is within range and stops, your vehicle also stops. The Stopped message appears on the Driver Information Interface.

When the vehicle ahead of you starts again, the vehicle icon on the Driver Information Interface blinks. Press the RES/+ button or the -/SET button, or press the accelerator pedal to resume the prior set speed.

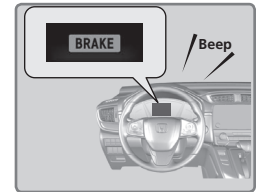

### ■ Canceling ACC

Press the CANCEL or MAIN buttons, or the brake pedal.

Certain conditions may cause ACC to cancel automatically. When this happens, a message appears on Driver Information Interface.

After adaptive cruise control has been canceled, you can still resume the prior set speed by pressing the RES/+ button.

Press the MAIN button to turn the system off.

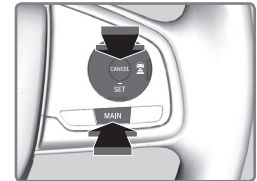

**⚠ WARNING**

Exiting a vehicle that has been stopped while the ACC with LSF system is operating can result in the vehicle moving without operator control.

A vehicle that moves without operator control can cause a crash, resulting in serious injury or death.

Never exit a vehicle when the vehicle is stopped by ACC with LSF.

**⚠ WARNING**

ACC with LSF has limited braking capability and may not stop your vehicle in time to avoid a collision with a vehicle that quickly stops in front of you.

Always be prepared to apply the brake pedal when conditions require.

**⚠ WARNING**

Improper use of ACC with LSF can lead to a crash.

Use ACC with LSF only when driving on expressways or freeways and in good weather conditions.

**Lane Keeping Assist System (LKAS)\***

A camera mounted between the windshield and the rearview mirror determines if your vehicle begins to move away from the center of a detected lane while driving between 45–90 mph (72–145 km/h).

If you cross a detected lane line without using your turn signal, a message appears on the DII and a beep sounds. Light steering torque is applied to help keep your vehicle within the lane.

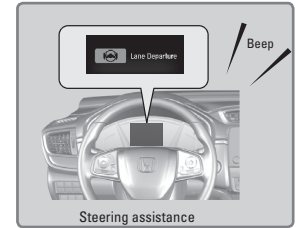
**■ Turning LKAS On or Off**

1. Press the MAIN button. LKAS appears in the driver information interface (DII).
2. Press the LKAS button. Lane outlines appear in the DII. Dotted lane lines turn solid when the system starts operating.
3. Press the MAIN or LKAS button to turn the system off.

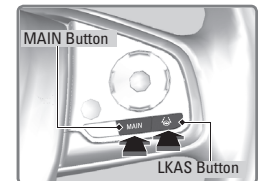
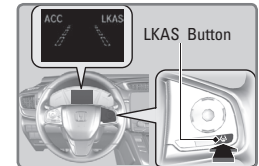
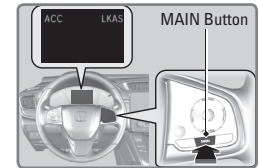
**Important Safety Reminder**

LKAS is for your convenience only. It is not a substitute for your vehicle control. The system does not work if you take your hands off the steering wheel or fail to steer the vehicle.

Do not place an object on the top of the instrument panel. It may reflect onto the windshield and prevent the system from detecting lane lines properly.

## Road Departure Mitigation (RDM)\*

Alerts and helps to assist you if the system determines a possibility of your vehicle unintentionally crossing over detected lane markings while driving between 45–90 mph (72–145 km/h).

If your vehicle is getting too close to detected lane markings without a turn signal activated, a message appears in the Driver Information Interface. Steering wheel torque and vibrations are applied to help your vehicle stay in the lane.

Braking may also be applied if the lane lines are solid and continuous.

If the system operates several times without detecting driver response, the system beeps to alert you.



### Turning the System On or Off

Press the RDM button to turn the system on or off. A green indicator appears on the button when the system is on.

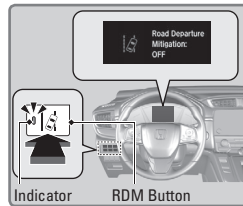

### Changing Settings

Determine the warning type. The vehicle must be in Park (P).

1. From the HOME screen, select Settings.
2. Select Vehicle.
3. Select Driver Assist System Setup.
4. Select Road Departure Mitigation Setting.
5. Select from the options.

*Normal (default):* Steering control starts from inside the lane edge.

*Wide:* Steering control starts from outside the lane edge.

*Warning Only:* The system only provides a BRAKE message and steering wheel vibrations, but does not apply steering torque or braking.

6. Press Yes, then press BACK to exit.

### Important Safety Reminder

The RDM system has limitations. Over-reliance on it may result in a collision. It is always your responsibility to keep your vehicle within the driving lane.

\*if equipped

## Collision Mitigation Braking System™ (CMBS™)\*

Can alert you when a potential frontal collision with a vehicle or pedestrian is determined and reduce your vehicle speed when a collision is deemed unavoidable to help minimize collision severity.

The system provides visual and audible alerts if you do not take appropriate action to avoid a collision.

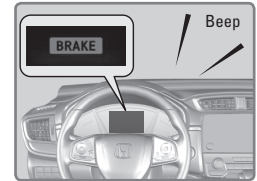

### Alert Stages

The system has three alert stages for a possible collision. Depending on the circumstances or CMBS settings, CMBS may not go through all of the stages before initiating the last stage.

**Stage 1:** Visual warnings and audible warning

**Stage 2:** Visual warnings, audible warning, and light brake application

**Stage 3:** Visual warnings, audible warning, and strong brake application

### Turning CMBS On or Off

Press and hold the CMBS OFF button. A beep sounds and a message appears in the DII. The CMBS indicator appears when the system is off.

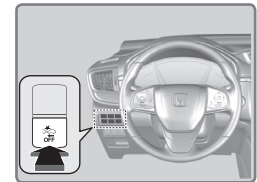

### Changing Settings

Determine the warning timing.

1. From the HOME screen, select Settings.
2. Select Vehicle. The vehicle must be in Park (P).
3. Select Driver Assist System Setup.
4. Select Forward Collision Warning Distance.
5. Select Long, Normal, or Short.
6. Press BACK to exit the menu.

### Important Safety Reminder

CMBS is designed to reduce the severity of an unavoidable collision. It does not prevent collision nor stop the vehicle automatically. It is still your responsibility to operate the brake pedal and steering wheel appropriately according to the driving conditions.

\*if equipped

## Cross Traffic Monitor\*

Alerts you if a detected vehicle is approaching from a rear corner when your vehicle is in Reverse (R) at speeds of 3 mph (5 km/h) or lower, which can be helpful when backing out of parking spaces.

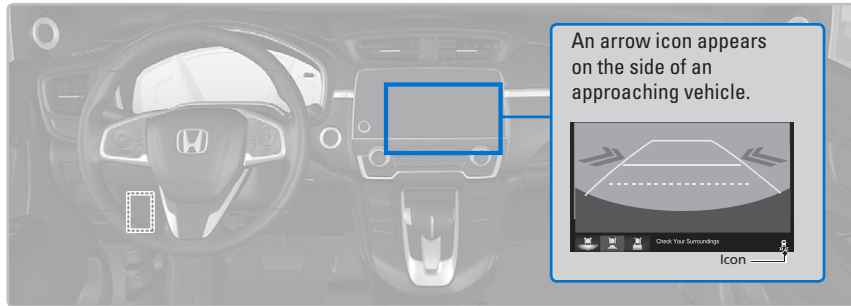

The system does not provide alerts for a vehicle that is moving away from your vehicle, and it may not detect pedestrians, bicycles, or stationary objects.

### ■ Turning the System On or Off

1. From the HOME screen, select Settings.
2. Select Camera.
3. Select Cross Traffic Monitor.
4. Select On or Off, then select OK.

You can also select the icon on the lower right corner of the screen when the monitor is on to turn it off.

### ⚠ CAUTION

This system cannot detect all approaching vehicles and may not detect an approaching vehicle at all.

Failure to visually confirm that it is safe to back up the vehicle before doing so may result in a collision.

Do not solely rely on the system when reversing; always also use your mirrors, and look behind and to the sides of your vehicle before reversing.

\*if equipped

## LaneWatch™\*

Check the passenger-side rear areas in the upper display when the right turn signal is activated.

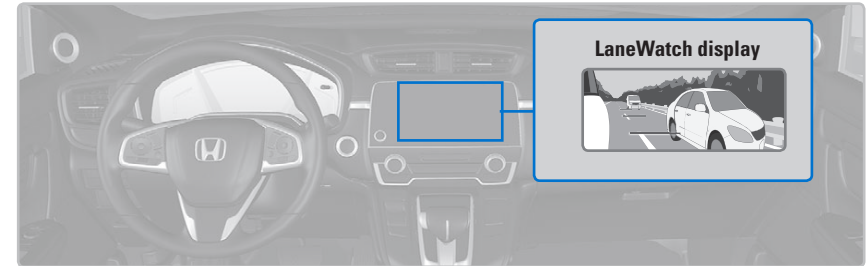

### ■ Activating LaneWatch

Activate the right turn signal. The LaneWatch display appears. Check the display for blind spots, and visually confirm that it is safe to change lanes.

You can also press the LaneWatch button on the end of the turn signal switch to view a constant real-time display. Press it again to turn the display off.

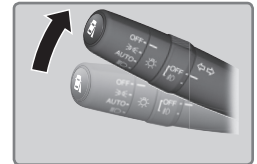

### ■ Changing Settings

Customize the display and how and when the display appears.

1. From the HOME screen, select Settings.
2. Select Camera.
3. Select LaneWatch.
4. Select an option and make the preferred changes.
5. Press the BACK button to exit the menu.

### Important Safety Reminder

Like all assistance systems, LaneWatch has limitations. Over-reliance on the system may result in a collision.

### ⚠ WARNING

Failure to visually confirm that it is safe to change lanes before doing so may result in a crash and serious injury or death.

Do not rely only on LaneWatch while driving. Always look in your mirrors, to either side of your vehicle, and behind you for other vehicles before changing lanes.

\*if equipped

## Multi-View Rear Camera

When you shift into Reverse (R), a real-time image of the area behind your vehicle is shown in the display, along with helpful parking guidelines.

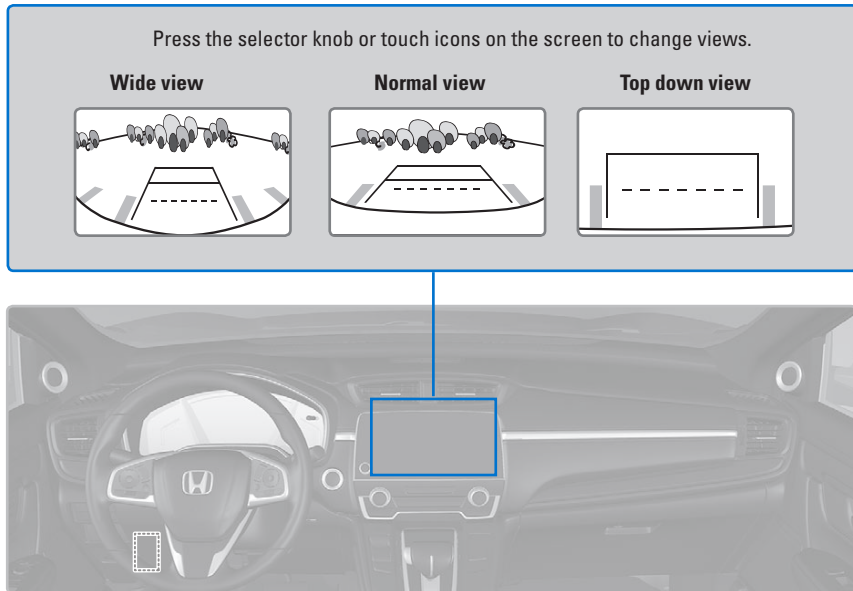

*The rear camera view is restricted. You cannot see the corner ends of the bumper or what is underneath the bumper. Its unique lens also makes objects appear closer or farther than they actually are.*

*Visually confirm that it is safe to drive before backing up. Certain conditions (such as weather, lighting, and high temperatures) may also restrict the rear view. Do not rely on the rearview display, which does not give you all the information about conditions at the rear of your vehicle.*

## ■ Changing Camera Settings

Turn the guidelines on or off.

### Models with color audio system

1. Press the HOME button.
2. Select Settings.
3. Select Camera.
4. Select Rear Camera.
5. Select Camera Guideline.
6. Select On or Off.
7. Press the Back button to exit the menu.

### Models with Display Audio

1. From the Home screen, select Settings.
2. Select Camera.
3. Select Rear Camera.
4. Select an option:
  - Fixed Guideline:* Guidelines appear when you shift into Reverse.
  - Dynamic Guideline:* Guidelines move as you turn the steering wheel.
5. Select On or Off.
6. Press BACK to exit the menu.

## Blind Spot Information (BSI)\*

Alerts you to a detected vehicle in your left or right blind spot while driving 20 mph (32 km/h) or higher.

When a vehicle is detected in your blind spot, the blind spot indicator turns on and stays lit until the area is clear.

When your turn signal is on and a vehicle is detected, the blind spot indicator blinks and a beep sounds until the area is clear or the turn signal is off.

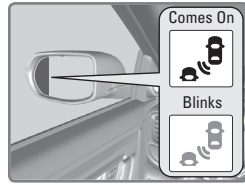

### ■ Changing Settings

Determine the warning type or turn the system off. The vehicle must be in Park (P).

1. From the Home screen, select Settings.
2. Select Vehicle.
3. Select Driver Assist System Setup.
4. Select Blind Spot Info.
5. Select an alert type or turn the system off.
6. Press BACK to exit the menu.

### Important Safety Reminder

Like all assistance systems, BSI has limitations. Over-reliance on the system may result in a collision. The system is for your convenience only.

### ⚠ WARNING

Failure to visually confirm that it is safe to change lanes before doing so may result in a crash and serious injury or death. Do not rely only on the blind spot information system when changing lanes.

Always look in your mirrors, to either side of your vehicle, and behind you for other vehicles before changing lanes.

## Refueling

Use the proper fuel and refueling procedure to ensure the best performance and safety of your vehicle.

### ■ Fuel Information

**Use of unleaded gasoline of 87 octane or higher is recommended.**

- Honda recommends TOP TIER Detergent Gasoline where available.
- Do NOT use gasoline containing more than 15% ethanol.
- Do NOT use gasoline containing methanol.
- Do NOT use gasoline containing MMT.

### NOTICE

We recommend quality gasoline containing detergent additives that help prevent fuel system and engine deposits. In addition, in order to maintain good performance, fuel economy, and emissions control, we strongly recommend the use of gasoline that does NOT contain harmful manganese-based fuel additives such as MMT, if such gasoline is available.

### ■ How to Refuel

1. The fuel fill door is located at the left rear of the vehicle. Park next to the service pump that is most accessible.
2. Turn off the engine.
3. Pull on the fuel fill door release handle under the lower left corner of the dashboard.
4. Place the end of the filler nozzle on the lower part of the filler opening, then insert it slowly and fully.
5. After filling, wait about 5 seconds before removing the filler nozzle. Close the fuel fill door by hand.

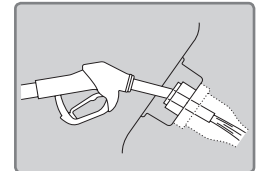
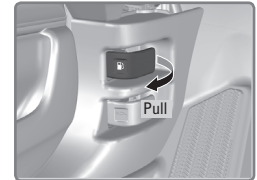

### ⚠ WARNING

Gasoline is highly flammable and explosive. You can be burned or seriously injured when handling fuel.

Stop the engine, and keep heat, sparks, and flame away.

Handle fuel only outdoors.

Wipe up spills immediately.

### NOTICE

The fuel filler opening is designed to accept only service station filler nozzles for refueling. Use of smaller diameter tubes (e.g., to siphon fuel for other uses) or other non-service station devices can damage the area in and around the filler opening.



## HANDLING THE UNEXPECTED

Learn about what to do in critical or emergency situations.

### Smart Entry Remote Battery Strength\*

If the battery life in your remote transmitter is weak, a message appears in the display with information on how to start the engine.

1. Touch the back of the remote transmitter to the ENGINE START/STOP button while the indicator is flashing.
2. With the brake pedal pressed, press the ENGINE START/STOP button within 10 seconds.

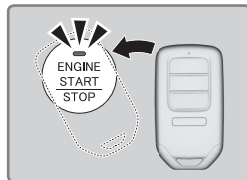

### Shift Lever Does Not Move

Follow the procedure below if you cannot move the shift lever out of Park (P).

1. Set the parking brake.
2. Remove the key from the ignition or remove the built-in key from the remote transmitter.
3. Wrap a cloth around the tip of a small flat-tip screwdriver to remove the cover of the shift lock release slot. Put the tip of the flat-tip screwdriver into the slot and remove it as shown in the image.
4. Insert the key into the shift lock release slot.
5. While pushing the key down, press the shift lever release button and place the shift lever into Neutral (N). The lock is now released. Have the shift lever checked by a dealer as soon as possible.

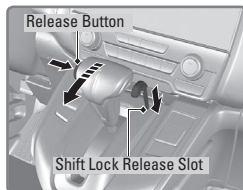
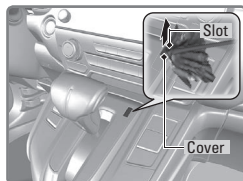

### Jump Starting

Turn off the power to electric devices, such as audio and lights. Turn off the engine, then open the hood.

1. Open the fuse box cover on your vehicle's battery (+) terminal.
2. Connect the first jumper cable to your vehicle's battery (+) terminal.
3. Connect the other end of the first jumper cable to the booster battery (+) terminal. Use a 12-volt booster battery only.
4. Connect the second jumper cable to the booster battery (-) terminal.
5. Connect the other end of the second jumper cable to the engine mounting bolt. Do not connect this jumper cable to any other part.
6. If your vehicle is connected to another vehicle, start the assisting vehicle's engine and increase its rpm slightly.
7. Attempt to start your vehicle's engine. If it turns over slowly, make sure that the jumper cables have good metal-to-metal contact.

**WARNING:** Battery posts, terminals, and related accessories contain lead and lead compounds. Wash your hands after handling.

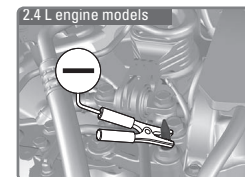
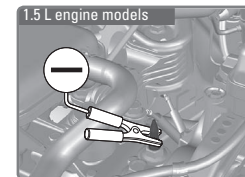
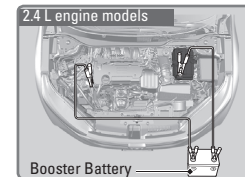
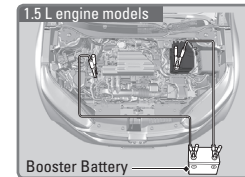
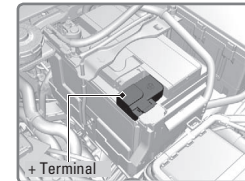

### **WARNING**

A battery can explode if you do not follow the correct procedure, seriously injuring anyone nearby.

Keep all sparks, open flames, and smoking materials away from the battery.

*\*if equipped*



## ■ After the Engine Starts

Once your vehicle's engine has started, remove the jumper cables in the following order:

1. Disconnect the jumper cable from your vehicle's ground.
2. Disconnect the other end of the jumper cable from the assisting vehicle's (-) terminal.
3. Disconnect the jumper cable from your vehicle's (+) terminal.
4. Disconnect the other end of the jumper cable from the assisting vehicle's (+) terminal.
5. Have your vehicle inspected by a nearby service station or a dealer.

## Overheating

If the temperature gauge needle is at the H mark, the engine suddenly loses power, or steam or spray comes out from under the hood, your engine is overheating.

1. Immediately park the vehicle in a safe place. Turn off all accessories and turn on the hazard warning lights.
2. *If steam or spray is not present:* Keep the engine running and open the hood.

*If steam or spray is present:* Turn off the engine and wait until it subsides. Then open the hood.

3. Check that the cooling fan is operating and stop the engine once the temperature gauge needle comes down. If the cooling fan is not operating, immediately stop the engine.
4. Once the engine has cooled down, inspect the coolant level and check the cooling system components for leaks. If the coolant level in the reserve tank is low, add coolant until it reaches the MAX mark. If there is no coolant in the reserve tank, make sure the radiator is cool, then cover the radiator cap with a heavy cloth and open the cap. If necessary, add coolant up to the MAX mark, then put the cap back on.

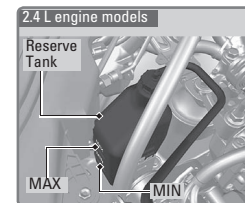
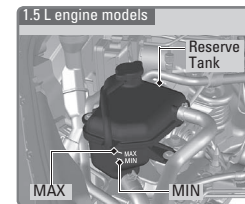

Once the engine has cooled sufficiently, restart it and check the temperature gauge. If the temperature needle has gone down, resume driving. If it has not gone down, contact a dealer for repairs.

### ⚠ WARNING

Steam and spray from an overheated engine can seriously scald you.  
Do not open the hood if steam is coming out.

### ⚠ WARNING

Removing the radiator cap while the engine is hot can cause the coolant to spray out, seriously scalding you.  
Always let the engine and radiator cool down before removing the radiator cap.

### NOTICE

Continuing to drive with the temperature gauge needle at the H mark may damage the engine.

## Refueling from a Portable Fuel Container

If you need to refuel your vehicle from a portable fuel container, use the funnel provided with your vehicle.

1. Turn off the engine.
2. Press on the edge of the fuel fill door to open it. The vehicle must be unlocked.
3. Take the funnel out of the tool case in the cargo area.
4. Place the end of the funnel on the lower part of filler opening, then insert it slowly and fully. Make sure that the end of the funnel goes down along with the filler pipe.
5. Fill the tank with fuel from the portable fuel container. Pour fuel carefully so you do not spill any.
6. Remove the funnel from the filler neck. Wipe up any fuel from the funnel before storing it.
7. Close the fuel fill door.

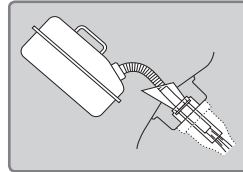
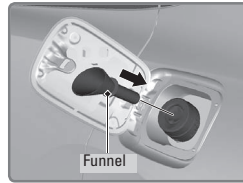

### NOTICE

Do not insert the nozzle of a portable fuel container or any funnel other than the one provided with your vehicle. Doing so can damage the fuel system.

Do not try to pry open or push open the sealed fuel tank with foreign objects. This can damage the fuel system and its seal.

*\*Canadian models only*

## Emergency Engine Stop\*

The ENGINE START/STOP button may be used to stop the engine due to an emergency situation even while driving. If you must stop the engine, choose one of the following operations:

- Press and hold the ENGINE START/STOP button for two seconds, or
- Firmly press the ENGINE START/STOP button three times.

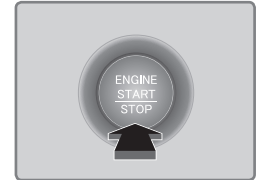

The steering wheel will not lock. The power mode changes to ACCESSORY, unless the shift lever is in Park (P), in which case the power mode changes to VEHICLE OFF.

Because turning off the engine also disables the power assist the engine provides to the steering and braking systems, it will require significantly more physical effort and time to steer and slow the vehicle. Downshift gears and use both feet on the brake pedal, if necessary, to slow the vehicle and stop immediately in a safe place.

### NOTICE

Do not press the button while driving unless it is absolutely necessary for the engine to be switched off.

## Emergency Towing

Call a professional towing service if you need to tow your vehicle.

### 2WD models

Flat bed equipment: The operator loads your vehicle on the back of a truck. **This is the best way to transport your vehicle.**

Wheel lift equipment: The tow truck uses two pivoting arms that go under the front tires and lift them off the ground. The rear tires remain on the ground. **This is an acceptable way to tow your vehicle.**

### AWD models

Flat bed equipment: The operator loads your vehicle on the back of a truck. **This is the ONLY way to transport your vehicle.**

### NOTICE

Trying to lift or tow your vehicle by the bumpers will cause serious damage. The bumpers are not designed to support the vehicle's weight.

Improper towing such as towing behind a motorhome or other motor vehicle can damage the transmission.

*\*if equipped*

## Tire Pressure Monitoring System (TPMS)

Monitors the tire pressure while you are driving.

If your vehicle's tire pressure becomes significantly low, the low tire pressure indicator comes on.

### ■ What to Do

Stop your vehicle in a safe place. Check the tire pressure and adjust the pressure to the specified level. The specified tire pressure is on a label on the driver's doorjamb.

#### NOTICE

Driving on an extremely underinflated tire can cause it to overheat. An overheated tire can fail. Always inflate your tires to the specified pressure.

### ■ TPMS Calibration

**Any time you inflate, change, or rotate one of more of the tires, you need to recalibrate the system.**

#### Models with information display

Press and hold the TPMS button until the low tire pressure indicator blinks twice, indicating the calibration process has begun.

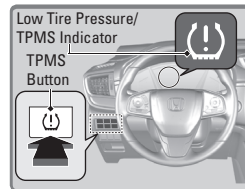

#### Models with Display Audio

Touch items on the screen to make and enter selections.

1. From the HOME screen, select Settings.
2. Select Vehicle.
3. Select TPMS Calibration.
4. Select Calibrate.

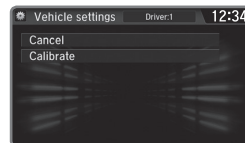

## ■ Tire Pressure Monitoring System (TPMS) — Required Federal Explanation

### U.S. models only

Each tire, including the spare (if provided), should be checked monthly when cold and inflated to the inflation pressure recommended by the vehicle manufacturer on the vehicle placard or tire inflation pressure label.

(If your vehicle has tires of a different size than the size indicated on the vehicle placard or tire inflation pressure label, you should determine the proper tire inflation pressure for those tires.)

As an added safety feature, your vehicle has been equipped with a tire pressure monitoring system (TPMS) that illuminates a low tire pressure telltale when one or more of your tires is significantly under-inflated.



Accordingly, when the low tire pressure telltale illuminates, you should stop and check your tires as soon as possible, and inflate them to the proper pressure.

Driving on a significantly under-inflated tire causes the tire to overheat and can lead to tire failure. Under-inflation also reduces fuel efficiency and tire tread life, and may affect the vehicle's handling and stopping ability.

Please note that the TPMS is not a substitute for proper tire maintenance, and it is the driver's responsibility to maintain correct tire pressure, even if under-inflation has not reached the level to trigger illumination of the TPMS low tire pressure telltale.

Your vehicle has also been equipped with a TPMS malfunction indicator to indicate when the system is not operating properly. The TPMS malfunction indicator is combined with the low tire pressure telltale. When the system detects a malfunction, the telltale will flash for approximately one minute and then remain continuously illuminated. This sequence will continue upon subsequent vehicle start-ups as long as the malfunction exists.

When the malfunction indicator is illuminated, the system may not be able to detect or signal low tire pressure as intended.

TPMS malfunctions may occur for a variety of reasons, including the installation of replacement or alternate tires or wheels on the vehicle that prevent the TPMS from functioning properly.

Always check the TPMS malfunction telltale after replacing one or more tires or wheels on your vehicle to ensure that the replacement or alternate tires and wheels allow the TPMS to continue to function properly.

## Changing a Flat Tire

If a tire goes flat while driving, grasp the steering wheel firmly and brake gradually to reduce speed. Then, stop in a safe place. Replace the flat tire with the compact spare tire. Go to a dealer as soon as possible to have the full-size tire repaired or replaced.

### ■ Getting Ready to Change the Tire

Park the vehicle on a firm, level, and non-slippery surface. Apply the parking brake, shift to Park (P), and turn the vehicle off. Turn on the hazard warning lights.

1. Open the cargo area floor lid.
2. Take the tool bag out of the cargo area. Take the jack handle bar and wheel nut wrench out of the tool bag.
3. Take the jack out of the spare tire area.
4. Unscrew the wing bolt and remove the spacer cone. Then remove the spare tire.
5. Place a wheel block or rock in front and rear of the wheel diagonal to the flat tire.
6. Place the compact spare tire (wheel side up) under the vehicle body, near the tire that needs to be replaced.
7. Loosen each wheel nut about one turn using the wheel nut wrench.

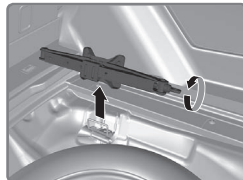
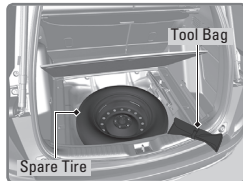
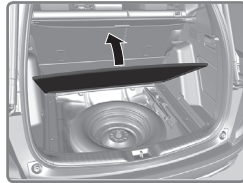

### ■ Setting Up the Jack

1. Place the jack under the jacking point closest to the tire to be changed.
2. Turn the end bracket clockwise (as shown) until the top of the jack contacts the jacking point. Make sure that the jacking point tab is resting in the jack notch.
3. Raise the vehicle, using the jack handle bar and the jack handle, until the tire is off the ground.

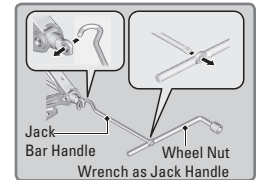
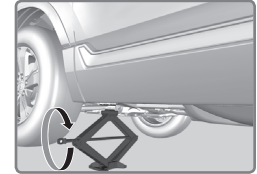
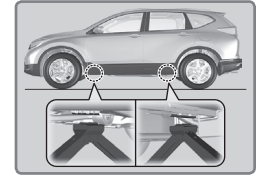

### ⚠ WARNING

The vehicle can easily roll off the jack, seriously injuring anyone underneath.

Follow the directions for changing a tire exactly, and never get under the vehicle when it is supported only by the jack.

The following instructions must be followed to use the jack safely:

- Do not use the jack with people or luggage in the vehicle.
- Use the jack provided in your vehicle. Other jacks may not support the weight ("load") or fit the jacking point.
- Do not use while the engine is running.
- Use only where the ground is firm and level.
- Use only at the jacking points.
- Do not get in the vehicle while using the jack.
- Do not put anything on top of or underneath the jack.

■ Replacing the Flat Tire

1. Remove the wheel nuts and flat tire.
2. Mount the compact spare tire. Replace the wheel nuts, and lightly tighten them.
3. Lower the vehicle and remove the jack. Tighten the wheel nuts in the order indicated in the image. Go around tightening the nuts, two to three times in this order. Do not overtighten the wheel nuts.
4. If you drive with the spare tire installed, the low tire pressure/TPMS indicator appears. The indicator stays on until a regular tire is installed.

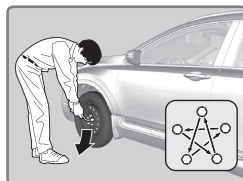
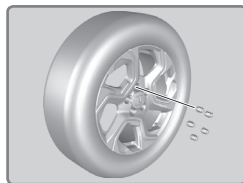

■ Storing the Flat Tire

1. Remove the center cap.
2. Place the flat tire face down in the spare tire well.
3. Remove the spacer cone from the wing bolt, flip it over, and insert it back on the bolt. Secure the flat tire with the wing bolt.
4. Securely store the wheel nut wrench and jack handle bar back in the tool bag. Store the bag in the cargo area.
5. Store the jack in its holder. Turn the jack's end bracket to lock it in place.

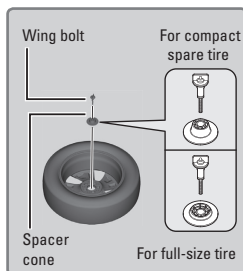

**⚠ WARNING**

Loose items can fly around the interior in a crash and can seriously injure the occupants.

Store the wheel, jack, and tools securely before driving.

Fuse Locations

If any electrical devices are not working, turn the vehicle off and check to see if any applicable fuse is blown. Fuse locations are shown on the fuse box cover. Locate the fuse in question by the fuse number and box cover number.

■ Engine Compartment Fuse Box

Located near the brake fluid reservoir. Push the tabs to open the box.

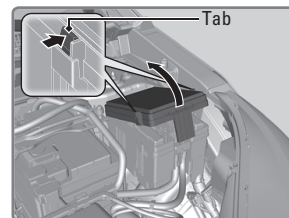

	Circuit Protected	Amps
	Audio AMP*	(30A)
	Electric Brake Booster	40A
1	Main Fan Motor	30A
	Relay Module 1	30A
	IG Main 2* <sup>2</sup>	(30A)
	Relay Module 2	30 A
	Battery	125 A
	EPS	70 A
	IG Main 1	30 A* <sup>2</sup>
2	Fuse Box	60 A
	Front Wiper Motor	30 A
	Sub Fan Motor	30 A
3	Rear Defroster	40 A
	Starter Motor	30 A
	Fuse Box	40 A
	ABS/VSA Motor	40 A
	ABS/VSA FSR	40 A
	Blower Motor	40 A
	Option Block 1 *	(40 A)
	Option Block 2 *	(40 A)
4	-	-
	Power Tail Gate*	(30 A)
5	VB ACT* <sup>4</sup>	(7.5 A)
6	Washer	15 A

	Circuit Protected	Amps
7	FI Main	15 A
8	FI Sub	15 A
9	Stop Lights	10 A
10	Injector	20 A
11	LAF	7.5 A
12	FI ECU* <sup>4</sup>	10 A
	-* <sup>5</sup>	-
13	Front Wiper Deicer*	(15 A)
14	Hazard	10 A
15	IG Coil	15 A
16	Transmission* <sup>4</sup>	(15 A)
	-* <sup>5</sup>	-
17	-	-
18	Back Up	10 A
19	Audio	15 A
20	AWD *	(20 A)
21	Rear Seat Heater* <sup>6</sup>	(20 A)
	-* <sup>7</sup>	-
22	Front Fog Lights* <sup>8</sup> /Lower Shutter Grille	(15 A)
23	A/C Compressor/Upper Shutter Grille	10 A
24	Horn	10 A
25	Cooling Fan	7.5 A
26	-	-
27	-	-
28	ST Magnetic Switch* <sup>3</sup>	(7.5 A)
29	-	-
30	-	-

\*1: Models with the smart entry system have an **ENGINE START/STOP** button instead of an ignition switch.

\*2: Models with smart entry system

\*3: Models without smart entry system

\*4: 1.5L engine models

\*5: 2.4L engine models

\*6: Canadian models with rear seat heater

\*7: Models without rear seat heater

\*8: Models with fog lights

## Interior Fuse Box

Located under the dashboard.

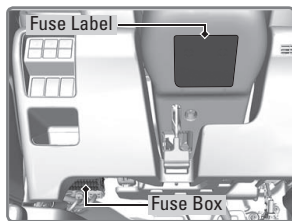

	Circuit Protected	Amps
1	Accessory	10 A
2	Key Lock	5 A
3	Option	15 A
4	Option *1 Transmission *2, *3	5 A (10 A)
5	Option	10 A
6	SRS Indicator	10 A
7	Meter	10 A
8	Fuel Pump	15 A
9	A/C	10 A
10	Accessory Power Socket (Center Console)	20 A
11	Engine Control *3	5 A
12	Passenger's Side Door Lock	10 A
13	Driver's Side Door Unlock	10 A
14	Rear Driver's Side Power Window	20 A
15	Front Passenger's Side Power Window	20 A
16	Door Lock	20 A
17	Transmission *1, *3 Option *2	(10 A) 5 A

\*1: Models with smart entry system

\*2: Models without smart entry system

\*3: 1.5L engine models

	Circuit Protected	Amps
18	Front Driver's Lumber support*	(10 A)
19	Moonroof*	(20 A)
20	Starter	10 A
21	ACG	10 A
22	Daytime Running Light	10 A
23	Steering Wheel Heater*1 Handsfree Power Tailgate Sensor*	(10 A)
24	Option	5 A
25	Driver's Door Lock	(10 A)
26	Passenger's Side Door Unlock	10 A
27	Rear Passenger's Side Power Window	20 A
28	Driver's Power Window	20 A
29	Front Accessory Power Socket	20 A
30	Smart Entry *1 STS*2	10 A 5 A
31	Driver's Power Seat Reclining*	(20 A)
32	Front Seat Heater*	(20 A)
33	Driver's Power Seat Sliding*	(20 A)
34	ABS/VSA	10 A
35	SRS	10 A
36	HAC Option*	20 A

\*Not available on all models

	Circuit Protected	Amps
37	Trailer*	15 A
38	Driver's Side Door Lock	10 A
39	Driver's Door Unlock	(10 A)
a	Power Tailgate Closer*	(20 A)
b	Passenger's Power Seat Sliding*	(20 A)
c	Passenger's Power Seat Reclining*	(20 A)
d	Panorama Shade Motor*3	(20 A)
e	-	-
f	-	-
g	-	-
h	Accessory Power Socket (Cargo Area)*4	(20 A)

\*1: Canadian models with steering heater

\*2: Models without smart entry system

\*3: Canadian models with panoramic roof

\*4: Canadian models

\*if equipped

## Inspecting and Changing Fuses

1. Turn the vehicle off, including all lights and accessories.
2. Remove the fuse box cover.
3. Check the large fuse in the engine compartment.

If the fuse is blown, use a Phillips-head screwdriver to remove the screws and replace the fuse with a new one. Reinstall the screws.

4. Inspect the small fuses in the engine compartment and the vehicle interior.

If there is a burned-out fuse, remove it with the fuse puller and replace it with a new one.

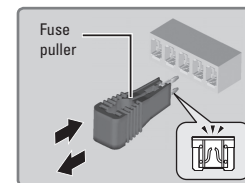
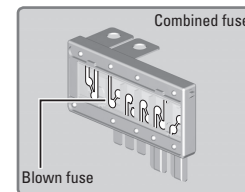

### NOTICE

Replacing a fuse with one that has a higher rating greatly increases the chances of damaging the electrical system.



# MAINTENANCE

Learn about basic maintenance that you can perform on the vehicle yourself, as well as information about how to best maintain the vehicle.

## Safety Precautions

Some of the most important safety precautions are listed below; however, we cannot warn you of every conceivable hazard that can arise in performing maintenance. Only you can decide whether or not you should perform a given task.

### ■ Maintenance Safety

- To reduce the possibility of fire or explosion, keep cigarettes, sparks, and flames away from the battery and all fuel-related parts.
- Never leave rags, towels, or other flammable objects under the hood. Heat from the engine and exhaust can ignite them causing a fire.
- To clean parts, use a commercially available degreaser or parts cleaner, not gasoline.
- Wear eye protection and protective clothing when working with the battery or compressed air.
- Do not run the engine in confined spaces where carbon monoxide gas can accumulate.

### ■ Vehicle Safety

- The vehicle must be stationary, and parked on level ground with the parking brake set and the engine off.
- Be aware that hot parts can burn you.
- Be aware that moving parts can injure you.

## ⚠ WARNING

Improperly maintaining this vehicle or failing to correct a problem before driving can cause a crash in which you can be seriously hurt or killed.

Always follow the inspection and maintenance recommendations according to the schedules in this guide.

## ⚠ WARNING

Failure to properly follow maintenance instructions and precautions can cause you to be seriously hurt or killed.

Always follow the procedures and precautions in this guide.

## Maintenance Minder™

Reminds you when indicated maintenance service is due.

### Models with information display

When maintenance is due, the Maintenance Minder indicator comes on and a message appears on the display every time you turn the vehicle on. Press the TRIP knob in the instrument panel to change displays (see page 28).

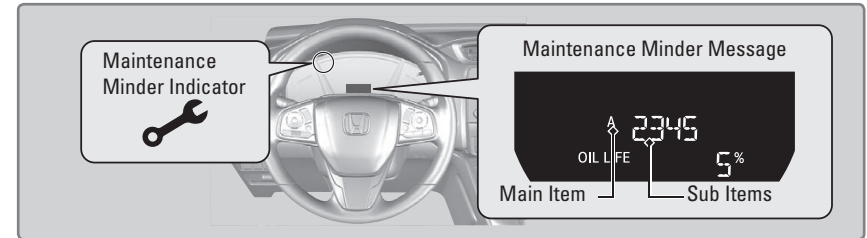

### Models with Driver Information Interface

When maintenance is due, the system message indicator comes on and a message appears on the display every time you turn the vehicle on. Press the Display/information button on the steering wheel to change displays (see page 29).

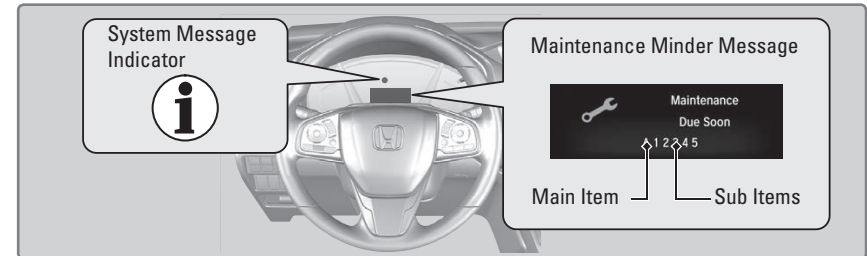

### U.S. models

**Maintenance, replacement, or repair of emissions control devices and systems may be done by any automotive repair establishment or individuals using parts that are certified to EPA standards.**

According to state and federal regulations, failure to perform maintenance on the maintenance main items marked with # will not void your emissions warranties. However, all maintenance services should be performed in accordance with the intervals indicated by the information display or driver information interface.

**Maintenance Minder Service Codes**

These codes indicate what services are due on your vehicle.

**U.S. models**

CODE	Maintenance Main Items
A	<ul style="list-style-type: none"> <li>• Replace engine oil*1</li> </ul>
B	<ul style="list-style-type: none"> <li>• Replace engine oil*1 and oil filter</li> <li>• Inspect front and rear brakes</li> <li>• Inspect these items:                             <ul style="list-style-type: none"> <li>• Tie rod ends, steering gearbox, and boots</li> <li>• Suspension components</li> <li>• Driveshaft boots</li> <li>• Brake hoses and lines (including ABS/VSA®)</li> <li>• All fluid levels and condition of fluids</li> <li>• Exhaust system<sup>f</sup></li> <li>• Fuel lines and connections<sup>f</sup></li> </ul> </li> </ul>

# : See information on maintenance and emissions warranty.

\*1: If a Maintenance Minder message does not appear more than 12 months after the display is reset, change the engine oil every year.

CODE	Maintenance Sub Items
1	<ul style="list-style-type: none"> <li>• Rotate tires</li> </ul>
2	<ul style="list-style-type: none"> <li>• Replace air cleaner element *2</li> <li>• Replace dust and pollen filter *3</li> <li>• Inspect drive belt</li> </ul>
3	<ul style="list-style-type: none"> <li>• Replace transmission fluid *4</li> </ul>
4	<ul style="list-style-type: none"> <li>• Replace spark plugs</li> <li>• Inspect valve clearance</li> </ul>
5	<ul style="list-style-type: none"> <li>• Replace engine coolant</li> </ul>
6	<ul style="list-style-type: none"> <li>• Replace rear differential fluid</li> </ul>
7	<ul style="list-style-type: none"> <li>• Replace brake fluid *5</li> </ul>

\*2: If you drive in dusty conditions, replace the air cleaner element every 15,000 miles (24,000 km).

\*3: If you drive primarily in urban areas that have high concentrations of soot in the air from industry and from diesel-powered vehicles, replace the dust and pollen filter every 15,000 miles (24,000 km).

\*4: Driving in mountainous areas at very low vehicle speeds or trailer towing results in higher transmission temperatures. This requires transmission fluid changes more frequently than recommended by the Maintenance Minder. If you regularly drive your vehicle under these conditions, have the transmission fluid changed every 25,000 miles (40,000 km).

\*5: If a Maintenance Minder Indicator does not appear more than 36 months after the display for item 7 is reset, change the brake fluid every 3 years.

In addition:

- Inspect idle speed every 160,000 miles (256,000 km).
- Adjust the valves during services A, B, 1, 2, or 3 if they are noisy.

**Canadian models**

CODE	Maintenance Main Items
A	<ul style="list-style-type: none"> <li>• Replace engine oil*1</li> </ul>
0	<ul style="list-style-type: none"> <li>• Replace engine oil*1 and oil filter</li> </ul>

\*1: If a Maintenance Minder message does not appear more than 12 months after the display is reset, change the engine oil every year.

CODE	Maintenance Sub Items
1	<ul style="list-style-type: none"> <li>• Rotate tires</li> </ul>
2	<ul style="list-style-type: none"> <li>• Replace air cleaner element*2</li> <li>• Replace dust and pollen filter*3</li> <li>• Inspect drive belt</li> </ul>
3	<ul style="list-style-type: none"> <li>• Replace transmission fluid*4</li> </ul>
4	<ul style="list-style-type: none"> <li>• Replace spark plugs</li> <li>• Inspect valve clearance</li> </ul>
5	<ul style="list-style-type: none"> <li>• Replace engine coolant</li> </ul>
6	<ul style="list-style-type: none"> <li>• Replace rear differential fluid</li> </ul>
7	<ul style="list-style-type: none"> <li>• Replace brake fluid*5</li> </ul>
9	<ul style="list-style-type: none"> <li>• Inspect front and rear brakes</li> <li>• Inspect these items:                             <ul style="list-style-type: none"> <li>• Tie rod ends, steering gearbox, and boots</li> <li>• Suspension components</li> <li>• Driveshaft boots</li> <li>• Brake hoses and lines (including ABS/VSA®)</li> <li>• All fluid levels and condition of fluids</li> <li>• Exhaust system<sup>f</sup></li> <li>• Fuel lines and connections<sup>f</sup></li> </ul> </li> </ul>

\*2: If you drive in dusty conditions, replace the air cleaner element every 24,000 km (15,000 miles).

\*3: If you drive primarily in urban areas that have high concentrations of soot in the air from industry and from diesel-powered vehicles, replace the dust and pollen filter every 24,000 km (15,000 miles).

\*4: Driving in mountainous areas at very low vehicle speeds results in higher transmission temperatures. This requires transmission fluid changes more frequently than recommended by the Maintenance Minder. If you regularly drive your vehicle under these conditions, have the transmission fluid changed every 40,000 km (25,000 miles).

\*5: If a Maintenance Minder Indicator does not appear more than 36 months after the display for item 7 is reset, change the brake fluid every 3 years.

# : See information on maintenance and emissions warranty.

In addition:

- Inspect idle speed every 256,000 km (160,000 miles).
- Adjust the valves during services A, 0, 1, 2, 3 or 9 if they are noisy.

## Under the Hood

### 1.5 L engine models

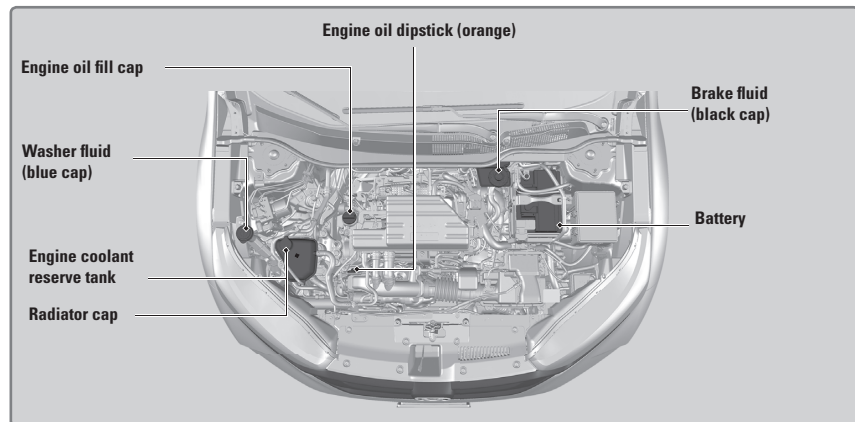

### 2.4 L engine models

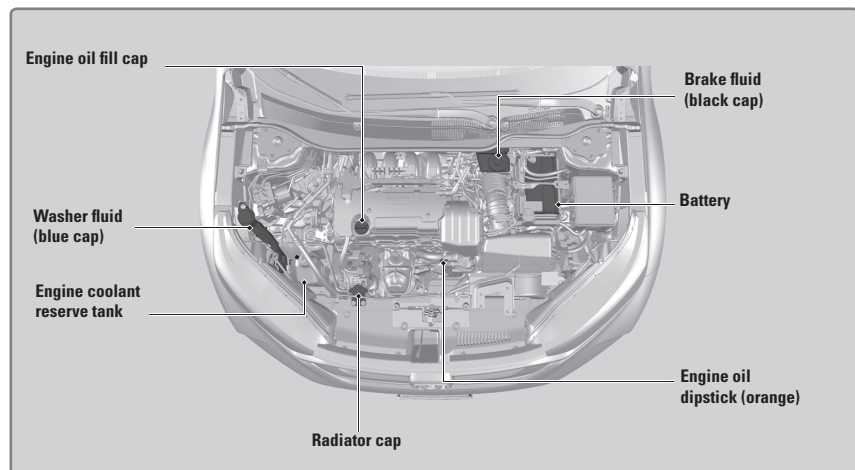

### ■ Opening the Hood

1. Park the vehicle on a level surface, and set the parking brake.
2. Pull the hood release handle under the lower left corner of the dashboard.
3. Slide the hood latch lever in the center of the hood to release the lock mechanism, and then open the hood.
4. Remove the support rod from the clamp using the foam grip. Mount the support rod in the hood.
5. When closing, remove the support rod, and stow it in the clamp, then gently lower the hood. Remove your hand at a height of approximately 12 inches (30 cm) and let the hood close.

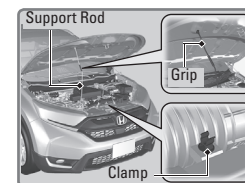
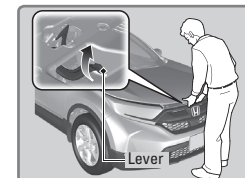
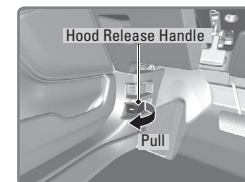

### NOTICE

Do not open the hood when the wiper arms are raised. The hood will strike the wipers, and may damage the hood and/or the wipers.

## Turbocharger\* Precautions

The engine uses an exhaust-driven turbocharger to generate extra power. The turbocharger is a precision device that can spin at over 100,000 rpm and reach temperatures over 1,292F (700C). It is lubricated and cooled by engine oil. Be sure to follow these precautions to help prevent turbocharger damage.

1. Always change the engine oil according to the Maintenance Minder.
2. Always allow the engine to warm before revving it or accelerating in a spirited way.

## Engine Oil

Park the vehicle on level ground, and wait approximately three minutes after turning the engine off before you check the oil.

### ■ Checking the Oil

1. Remove the dipstick (orange loop).
2. Wipe the dipstick with a clean cloth or paper towel.
3. Insert the dipstick back all the way into its hole.
4. Remove the dipstick again, and check the level. It should be between the upper and lower marks. Add oil if necessary.

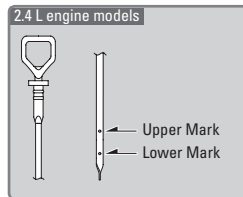
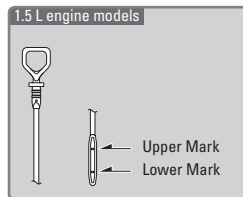
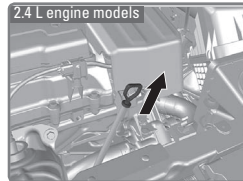
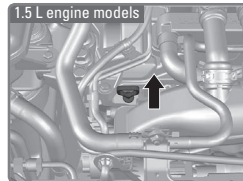

### NOTICE

Under certain driving conditions, it is normal for the engine oil level to rise above the upper mark. If you have a concern, consult a dealer for details.

*\*if equipped*

### ■ Recommended Engine Oil

- Honda Genuine Motor Oil
- Premium-grade 0W-20 detergent oil with an API Certification Seal on the container

This seal indicates the oil is energy conserving and that it meets the American Petroleum Institute's latest requirements.



Use Honda Genuine Motor Oil or another commercial engine oil of suitable viscosity for the ambient temperature as shown.

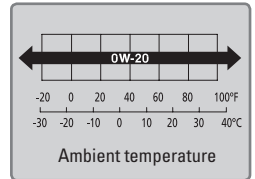

You may also use synthetic motor oil if it is labeled with the API Certification Seal and is of the specified viscosity grade.

### ■ Adding Oil

1. Unscrew and remove the engine oil fill cap.
2. Add oil slowly.
3. Reinstall the engine oil fill cap, and tighten it securely.
4. Wait for three minutes and recheck the engine oil dipstick.

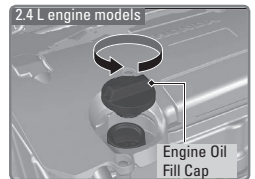
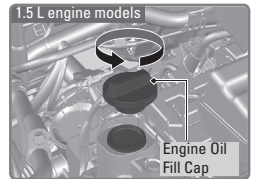

### NOTICE

Do not fill the engine oil above the upper mark. Overfilling the engine oil may result in leaks and engine damage.

### ■ Resetting the Engine Oil Life

If you change or replace the vehicle's engine oil yourself, you must reset the engine oil life.

#### Models with information display

1. Press the TRIP knob in the instrument panel until the engine oil life appears in the display.
2. Press and hold the knob for 10 seconds or more, until the display begins to blink.
3. Press and hold the knob for 5 seconds or more. The engine oil life display returns to 100%.

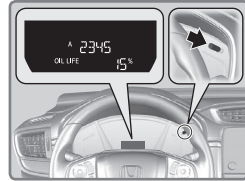

#### Models with Driver Information Interface

Use the steering wheel buttons to make and enter selections (see page 29).

1. Scroll to the Maintenance Minder screen, and select it.
2. Press and hold the ENTER button for about 10 seconds to enter the reset mode.
3. Scroll to the maintenance item you want to reset (or All Due Items), and select it.



#### Models with Display Audio

Use the touchscreen to make and enter selections.

1. From the HOME screen, select Settings.
2. Select Vehicle.
3. Select Maintenance Info.
4. Select Select Reset Items.
5. Select an item on the list to reset.



### NOTICE

Failure to reset the engine oil life after a maintenance service results in the system showing incorrect maintenance intervals, which can lead to serious mechanical problems.

## Engine Coolant

Park the vehicle on level ground. Check the reserve tank and the coolant level in the radiator. **Use Honda Long Life Antifreeze/Coolant Type 2.**

### ■ Checking the Reserve Tank

1. Check the amount of coolant in the reserve tank.
2. If the coolant level is below the MIN mark, add the specified coolant until it reaches the MAX mark.
3. Inspect the cooling system for leaks.

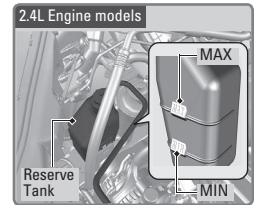
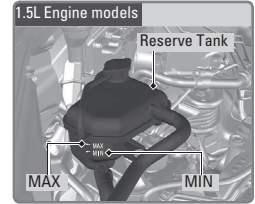

### ■ Adding Coolant

1. Make sure the engine and radiator are cool.
2. Turn the reserve tank cap counterclockwise and relieve any pressure in the coolant system. Do not push the cap down when turning.
3. Push down and turn the reserve tank cap counterclockwise to remove it.
4. The coolant level should be up to the MAX mark. Add coolant if it is low.
5. Put the reserve tank cap back on, and tighten it fully.

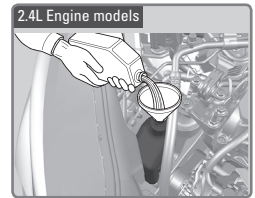
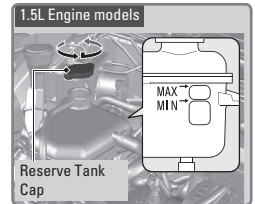

**⚠ WARNING**

Removing the reserve tank cap while the engine is hot can cause the coolant to spray out, seriously scalding you.

Always let the engine and radiator cool down before removing the reserve tank cap.

**NOTICE**

Pour the fluid slowly and carefully so you do not spill any. Clean up any spills immediately; they can damage components in the engine compartment.

**NOTICE**

If temperatures consistently below  $-31^{\circ}\text{F}$  ( $-35^{\circ}\text{C}$ ) are expected, the coolant mixture should be changed to a higher concentration. Consult a dealer for more information.

**Checking the Battery**

Check the battery terminals for corrosion monthly.

For jump starting, see page 127.

**⚠ WARNING**

The battery gives off explosive hydrogen gas during normal operation.

A spark or flame can cause the battery to explode with enough force to kill or seriously hurt you.

When conducting any battery maintenance, wear protective clothing and a face shield, or have a skilled technician do it.

**WARNING:** Battery posts, terminals, and related accessories contain lead and lead compounds. **Wash your hands after handling.**

**Brake Fluid**

The fluid level should be between the MIN and MAX marks on the side of the reservoir. **Use Honda Heavy Duty Brake Fluid DOT 3.**

Pour the fluid carefully.

If the fluid level is at or below the MIN mark, have a dealer inspect for leaks or worn brake pads as soon as possible.

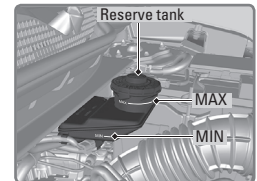
**NOTICE**

Brake fluid marked DOT 5 is not compatible with your vehicle's braking system and can cause extensive damage.

**Window Washer Fluid**

If the washer fluid level is low, fill the washer reservoir.

**Canadian models**

If the washer fluid level is low, the washer level indicator or a message appears.

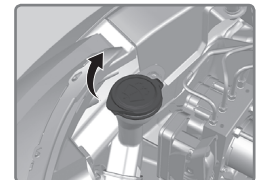
**NOTICE**

Do not use engine antifreeze or a vinegar/water solution in the windshield washer reservoir. Antifreeze can damage your vehicle's paint. A vinegar/water solution can damage the windshield washer pump.



## Changing Wiper Blades

Dirty wiper blades may leave streaks across the windshield. Cleaning them with a paper towel or soft cloth and wiper fluid often improves their performance. If the wiper blade rubber has deteriorated, you should change the wiper blades.

### ■ Changing the Front Wiper Blade Rubber

1. Lift the driver side wiper arm first, then the passenger side.
2. Press and hold the tab, then slide the holder off the wiper arm.
3. Slide the wiper blade out from its holder by pulling the tabbed end out.
4. Slide the new wiper blade onto the holder from the bottom end. The tab on the holder should fit in the indent of the wiper blade.
5. Attach the wiper holder to the wiper arm until the lock tab clicks into place.
6. Lower the passenger side wiper arm first, then the driver side.

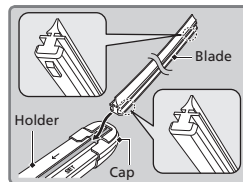
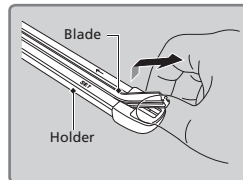
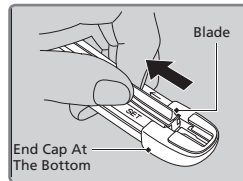
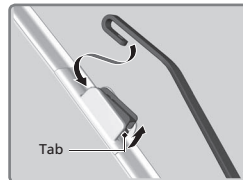
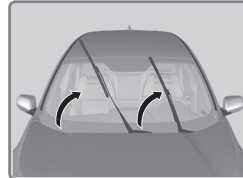

### ■ Changing the Rear Wiper Blade Rubber

1. Lift the wiper arm off the window.
2. Pivot the wiper blade holder until it releases from the wiper arm.
3. Slide the blade out of the holder.
4. Remove the retainers from the blade and mount it to a new rubber blade.
5. Slide the new wiper blade onto the holder. Make sure it is engaged correctly, then install the wiper blade holder onto the wiper arm.

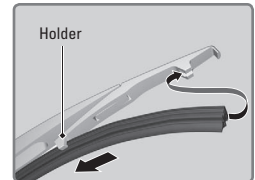
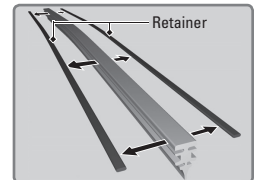
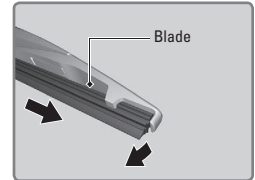
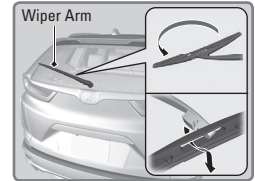

### NOTICE

Avoid dropping the wiper arm, as it may damage the windshield.

## Tire Information

To safely operate your vehicle, your tires must be of the proper type and size, in good condition with adequate tread, and properly inflated.

### Inflation Guidelines

- Properly inflated tires provide the best combination of handling, tread life, and comfort. Refer to the driver's doorjamb label or the specifications (see page 162) for the specified pressure.
- Underinflated tires wear unevenly, adversely affect handling and fuel economy, and are more likely to fail from overheating.
- Overinflated tires make your vehicle ride harshly, are more prone to road hazards, and wear unevenly.
- Every day before you drive, look at each of the tires. If one looks lower than the others, check the pressure with a tire gauge.
- Measure the air pressure when tires are cold. This means the vehicle has been parked for at least 3 hours, or driven less than 1 mile (1.6 km). If necessary, add or release air until the specified pressure is reached, and then calibrate the system (see page 132). If checked when hot, tire pressure can be as much as 4–6 psi (30–40 kPa, 0.3–0.5 kgf/cm<sup>2</sup>) higher than checked when cold.
- At least once a month or before long trips, use a gauge to measure the pressure in all tires, including the spare. Even tires in good condition can lose 1–2 psi (10–20 kPa, 0.1–0.2 kgf/cm<sup>2</sup>) per month.

### Inspection Guidelines

Every time you inflate the tires, check for the following:

- Any damage to tires, including bumps, bulges, cuts, splits, or cracks in the side or tread. Remove any foreign objects and inspect for air leaks. Replace tires if you see fabric or cord.
- Uneven or excessive tread wear. Have a dealer check the wheel alignment.
- Cracks or other damage around the valve stems.

### Wear Indicators

The groove where the wear indicator is located is 1/16 inch (1.6 mm) shallower than elsewhere on the tire. If the tread has worn so low that the indicator is exposed, replace the tire. **Worn out tires have poor traction on wet roads.**

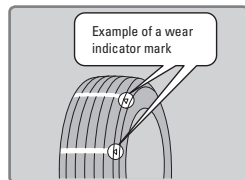

## ⚠ WARNING

Using tires that are excessively worn or improperly inflated can cause a crash in which you can be seriously hurt or killed.

Follow all instructions in this owner's manual regarding tire inflation and maintenance.

### Tire and Loading Information Label

The label attached to the driver's doorjamb provides necessary tire and loading information.

TIRE AND LOADING INFORMATION			
SEATING CAPACITY		TOTAL X	FRONT X REAR X
The combined weight of occupants and cargo should never exceed XXXkg or XXXlbs.			
TIRE	SIZE	COLD TIRE PRESSURE	SEE OWNER'S MANUAL FOR ADDITIONAL INFORMATION
FRONT	XXXX/XXXXX XXX	XXXKPA, XXPSI	
REAR	XXXX/XXXXX XXX	XXXKPA, XXPSI	
SPARE	XXXX/XXXXX XXX	XXXKPA, XXPSI	

### Tire and Wheel Replacement

Replace your tires with radials of the same size, load range, speed rating, and maximum cold tire pressure rating (as shown on the tire's sidewall). Using tires of a different size or construction can cause certain vehicle systems such as ABS and Vehicle Stability Assist® (VSA)® to work incorrectly. It is best to replace all four tires at the same time. If that isn't possible, replace the front or rear tires in pairs.

If you change or replace a wheel, make sure that the wheel's specifications match those of the original wheels. Only use TPMS-specified wheels approved for your vehicle.

## ⚠ WARNING

Installing improper tires on your vehicle can affect handling and stability.

This can cause a crash in which you can be seriously hurt or killed.

Always use the size and type of tires recommended in the Owner's Manual.

■ **Tire Service Life**

The life of your tires is dependent on many factors, including driving habits, road conditions, vehicle loading, inflation pressure, maintenance history, speed, and environmental conditions (even when the tires are not in use).

In addition to regular inspections and inflation pressure maintenance, it is recommended that you have annual inspections performed once the tires reach five years old. All tires, including the spare, should be removed from service after 10 years from the date of manufacture, regardless of their condition or state of wear.

■ **Winter Tires**

If driving on snowy or frozen roads, mount all season tires marked “M+S”, snow tires, or tire chains; reduce speed; and maintain sufficient distance between vehicles when driving. For winter tires, select the size and load ranges that are the same as the original tires, and mount them to all four wheels.

■ **Tire Chains**

Install tire chains on the front tires only. Because your vehicle has limited tire clearance, we strongly recommend using the following chains:

**Models with 235/65R17 tires:**

Cable type: SCC Radial Chain TC2111MM

**Models with 235/60R18:**

Cable type: SCC Radial Chain TC2212MM

Mount chains as tightly as you can, and make sure that they do not touch the brake lines or suspension.

**⚠ WARNING**

Using the wrong chains, or not properly installing chains, can damage the brake lines and cause a crash in which you can be seriously injured or killed.

Follow all instructions in this guide regarding the selection and use of tire chains.

**NOTICE**

Traction devices that are the wrong size or improperly installed can damage your vehicle’s brake lines, suspension, body, and wheels. Stop driving if they are hitting any part of the vehicle.

**Tire Labeling**

The tires that came on your vehicle have a number of markings. Those you should be aware of are described below.

Here is an example of what each marking means:

**P215/70R16 100S**

- P: vehicle type (passenger)
- 215: tire width in millimeters
- 70: aspect ratio (tire section height as a percentage of its width)
- R: tire construction code (radial)
- 16: rim diameter in inches
- 100: load index (code indicating maximum load tire can carry)
- S: speed symbol (code indicating maximum speed rating)

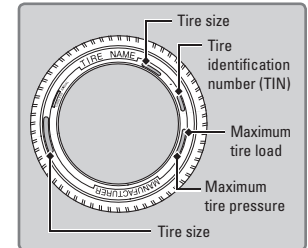

■ **Tire Identification Number (TIN)**

The tire identification number (TIN) is a group of numbers and letters that look like the example shown. TIN is located on the sidewall of the tire.

DOT B97R FW6X 2209  
 DOT: This indicates that the tire meets all requirements of the U.S. Department of Transportation.  
 B97R: Manufacturer’s identification mark  
 FW6X: Tire type code  
 22 09: Date of Transportation  
     └── Year  
     └── Week

## ■ Glossary of Tire Terminology

**Cold Tire Pressure** – The tire air pressure when the vehicle has been parked for at least three hours or driven less than 1 mile (1.6 km).

**Load Rating** – The maximum load that a tire is rated to carry for a given inflation pressure.

**Maximum Inflation Pressure** – The maximum tire air pressure that the tire can hold.

**Maximum Load Rating** – The load rating for a tire at the maximum permissible inflation pressure for that tire.

**Recommended Inflation Pressure** – The cold tire inflation pressure recommended by the manufacturer.

**Treadwear Indicators (TWI)** – The projections within the principal grooves designed to give a visual indication of the degrees of wear of the tread.

## DOT Tire Quality Grading

The tires on your vehicle meet all U.S. Federal Safety Requirements. All tires are also graded for treadwear, traction, and temperature performance according to Department of Transportation (DOT) standards. The following explains these gradings.

### ■ Uniform Tire Quality Grading

Quality grades can be found where applicable on the tire sidewall between tread shoulder and maximum section width.

*For example:*

**Treadwear 200**

**Traction AA**

**Temperature A**

All passenger car tires must conform to Federal Safety Requirements in addition to these grades.

### ■ Treadwear

The treadwear grade is a comparative rating based on the wear rate of the tire when tested under controlled conditions on a specified government test course. For example, a tire graded 150 would wear one and one-half (1 1/2) times as well on the government course as a tire graded 100. The relative performance of tires depends upon the actual conditions of their use, however, and may depart significantly from the norm due to variations in driving habits, service practices, and differences in road characteristics and climate.

### ■ Traction

The traction grades, from highest to lowest, are AA, A, B, and C. Those grades represent the tire's ability to stop on wet pavement as measured under controlled conditions on specified government test surfaces of asphalt and concrete. A tire marked C may have poor traction performance.

**WARNING:** The traction grade assigned to this tire is based on straight-ahead braking traction tests, and does not include acceleration, cornering, hydroplaning, or peak traction characteristics.

## ■ Temperature

The temperature grades are A (the highest), B, and C, representing the tire's resistance to the generation of heat and its ability to dissipate heat when tested under controlled conditions on a specified indoor laboratory test wheel. Sustained high temperature can cause the material of the tire to degenerate and reduce tire life, and excessive temperature can lead to sudden tire failure. The grade C corresponds to a level of performance which all passenger car tires must meet under the Federal Motor Vehicle Safety Standard No. 109. Grades B and A represent higher levels of performance on the laboratory test wheel than the minimum required by law.

**WARNING:** The temperature grade for this tire is established for a tire that is properly inflated and not overloaded. Excessive speed, underinflation, or excessive loading, either separately or in combination, can cause heat buildup and possible tire failure.

## Air Conditioning Maintenance

To ensure proper and safe operation, the Society of Automotive Engineers (SAE J2845) recommends that the refrigerant system only be serviced by trained and certified technicians.

Never repair or replace the air conditioning evaporator (cooling coil) with one removed from a used or salvaged vehicle. New replacement mobile air conditioning evaporators must be certified (and labeled) as meeting SAE Standard J2842.

### NOTICE

Vented refrigerant is harmful to the environment. To avoid refrigerant from venting, never replace the evaporator with one removed from a used or salvaged vehicle.

Refrigerant in your vehicle's air conditioning system is flammable and can be ignited during servicing if proper procedures are not followed.

An air conditioning safety label is found under the hood.

## Testing of Readiness Codes

Your vehicle has readiness codes as part of the onboard self-diagnostic system. Some states use these codes for testing to verify whether your vehicle's emissions components are working properly. The codes may not be read if you go through the testing just after the battery has gone dead or been disconnected.

To check if they are set, turn the vehicle on without starting the engine. The malfunction indicator lamp will come on for several seconds. If it goes off, the readiness codes are set. If it blinks five times, the readiness codes are not set.

If you are required to have your vehicle tested before the readiness codes are set, prepare the vehicle for retesting by doing the following:

1. Fill the gas tank to approximately 3/4 full.
2. Park the vehicle and leave the engine off for 6 hours or more.
3. Make sure the ambient temperature is between 40°F and 95°F (4°C and 35°C).
4. Start the engine without touching the accelerator pedal, and let it idle for 20 seconds.
5. Keep the vehicle in Park (P). Increase the engine speed to 2,000 rpm, and hold it there for about 3 minutes.
6. Let the engine idle with your foot off the accelerator for 20 seconds.
7. Select a nearby, lightly traveled major highway where you can maintain a speed of 50 to 60 mph (80 to 97 km/h) for at least 20 minutes. Drive on the highway with the vehicle in Drive. Do not use cruise control. When traffic allows, drive for 90 seconds without using the accelerator pedal. (Vehicle speed may vary slightly; this is OK.) If you cannot do this for a continuous 90 seconds because of traffic conditions, drive for at least 30 seconds, then repeat two more times (for a total of 90 seconds).
8. Drive in city or suburban traffic for at least 10 minutes. When traffic conditions allow, let the vehicle coast for several seconds without using the accelerator pedal or the brake pedal.
9. Park the vehicle and leave the engine off for 30 minutes.

The readiness codes are erased when the battery is disconnected, and set again only after several days of driving under a variety of conditions.

If a testing facility determines that the readiness codes are not set, you may be requested to return at a later date to complete the test, or see your dealer.

# SPECIFICATIONS

## Vehicle

Model	Honda CR-V	
No. of Passengers:		
Front	2	
Rear	3	
Total	5	
Weights:		
Gross Vehicle Weight	U.S.:	4,695 lbs (2,130 kg)
Rating	Canada:	2,130 kg
Gross Axle Weight	U.S.:	2,425 lbs (1,100 kg)
Rating (Front)	Canada:	1,100 kg
	U.S.:	2,292 lbs (1,040 kg) <sup>*1</sup>
Gross Axle Weight		2,369 lbs (1,075 kg) <sup>*2</sup>
Rating (Rear)	Canada:	1,040 kg <sup>*1</sup>
		1,075 kg <sup>*2</sup>

\*1: 2WD models

\*2: AWD models

## Engine and Fuel

### Engine Specifications

Displacement	143.72 cu-in (2,356 cm <sup>3</sup> ) <sup>*1</sup> 91.38 cu-in (1,498 cm <sup>3</sup> ) <sup>*2</sup>	
Spark Plugs	NGK	DILKAR7H11GS <sup>*1</sup> DILKAR7G11GS <sup>*1</sup> ILZKAR8JBSY <sup>*2</sup>
	DENSO	DXE22HQR-D11S <sup>*1</sup>

### Fuel

Type	Unleaded gasoline, Pump octane number of 87 or higher
Fuel Tank Capacity	14 US gal (53 L)

\*1: 2.4 L engine models

\*2: 1.5 L engine models

## Tires

Regular	Size <sup>*1</sup>	235/65R17 104H	
	Pressure <sup>*1</sup>	Front	32 (220 [2.2])
	psi (kPa [kgf/cm <sup>2</sup> ])	Rear	30 (210 [2.1])
	Size <sup>*2</sup>	235/60R18 103H	
Compact Spare	Pressure <sup>*2</sup>	Front	33 (230 [2.3])
	psi (kPa [kgf/cm <sup>2</sup> ])	Rear	30 (210 [2.1])
	Size	T155/90D17 112M	
	Pressure	60 (420 [4.2])	
Wheel Size	Regular	17 x 7 1/2J <sup>*1</sup> 18 x 7 1/2J <sup>*2</sup>	
	Compact Spare	17 x 4T	

\*1: Vehicle with 17 inch wheel

\*2: Vehicle with 18 inch wheel

## Air Conditioning

Refrigerant Type	HFO-1234yf (R-1234yf)	
Charge Quantity	14.6 – 16.4 oz (415 – 465 g) <sup>*1</sup> 15.3 – 17.1 oz (435 – 485 g) <sup>*2</sup>	
Lubricant Type	RB100EV-01 <sup>*1</sup> RL85HM (POE) <sup>*2</sup>	
Quantity	5.80 – 6.53 cu-in (95 – 107 cm <sup>3</sup> ) <sup>*1</sup> 4.70 – 6.28 cu-in (77 – 103 cm <sup>3</sup> ) <sup>*2</sup>	

\*1: 2.4 L engine models

\*2: 1.5 L engine models

## Light Bulbs

Headlights (Low Beam)	55 W (H11)* LED*
Headlights (High Beam)	60 W (HB3)* LED*
Fog Lights*	35 W (H8)
Front Turn Signal/ Front Side Marker Lights	LED
Daytime Running/Parking Lights	LED
Side Turn Signal Lights	LED
Tail and Brake/Rear Turn Signal/ Rear Side Marker Lights	LED
Back-Up Lights	16W
Taillights	LED
High-Mount Brake Light	LED
Rear License Plate Light	LED
Interior Lights	
Map Lights	8W*LED*
Ceiling Light	8W*
Cargo Area Light	5W
Vanity Mirror Lights*	1.8 W

## Fluids

### Brake Fluid

Specified	Honda Heavy Duty Brake Fluid DOT 3
-----------	------------------------------------

### Continuously Variable Transmission Fluid

Specified	Honda HCF-2 Transmission Fluid	
Capacity	Change	3.9 US qt (3.7 L) <sup>*1</sup> 4.5 US qt (4.3 L) <sup>*2</sup>

\*1: 2WD models

\*2: AWD models

### Rear Differential Fluid\*

Specified	Honda DPSF-II	
Capacity	Change	1.32 US qt (1.24 L)
	Total	1.57 US qt (1.48 L)

### Engine Oil

Recommended	Genuine Honda Motor Oil 0W-20 -API Premium-grade 0W-20 detergent oil	
Capacity	Change	4.4 US qt (4.2 L) <sup>*1</sup>
		3.4 US qt (3.2 L) <sup>*2</sup>
	Change including 4.7 US qt (4.4 L) <sup>*1</sup> filter	3.7 US qt (3.5 L) <sup>*2</sup>

\*1: 2.4 L engine models

\*2: 1.5 L engine models

### Engine Coolant

Specified	Honda Long Life Antifreeze/Coolant Type2	
Ratio	50/50 with distilled water	
Capacity		1.65 US gal (6.24 L) <sup>*1</sup>
		1.64 US gal (6.20 L) <sup>*2</sup>
		(change including the remaining 0.17 US gal (0.65 L) in the reserve tank) <sup>*1</sup>
		(change including the remaining 0.2 US gal (0.75 L) in the reserve tank) <sup>*2</sup>

\*1: 2.4 L engine models

\*2: 1.5 L engine models

# CUSTOMER INFORMATION

Learn about information specific to you as a Honda customer and how to get help.

## Frequently Asked Questions/Troubleshooting

Below are some frequently asked questions and troubleshooting items that you may have about the vehicle.

**Q:** How do I set the vehicle clock?

**A:** For vehicles without navigation, see page 61. For vehicles with navigation, the time is automatically set using GPS signals.

**Q:** Why doesn't the vehicle start when I press the ENGINE START/STOP button\*?

**A:** The brake pedal must be pressed to start the engine.

**Q:** What is the AUTO setting on my headlight lever?

**A:** When in the AUTO position, the vehicle's exterior lights will automatically turn on or off depending on the ambient lighting.

**Q:** Why won't the driver's door unlock when I grab the door handle, even though the keyless access remote is within range\*?

**A:** If you pull the handle too quickly, the system may not have time to confirm the door is unlocked. Wait to hear a beep to confirm the door is unlocked. If you are wearing gloves, the system may be slow to respond.

**Q:** After my battery was disconnected or went dead, the audio system is asking for a code. Where do I find this?

**A:** In most cases, you do not need to enter a code. Turn on the vehicle and the audio system, and press and hold the power button until the system reactivates.

**Q:** Why can't I operate Pandora<sup>®</sup> through the audio system?

**A:** Audio may be streaming through Bluetooth<sup>®</sup> Audio. Make sure Pandora mode is selected and the phone cable is properly connected to the USB adapter. Some phones may prompt you to "Allow" a connection.

**Q:** Is my phone compatible with Bluetooth features?

**A:** Visit [automobiles.honda.com/handsfreelink/](http://automobiles.honda.com/handsfreelink/) (U.S.) or [handsfreelink.ca](http://handsfreelink.ca) (Canada) to check phone compatibility for Bluetooth<sup>®</sup> Audio, Bluetooth<sup>®</sup> HandsFreeLink<sup>®</sup>, and SMS text messaging.

**Q:** Every time I press the Talk button, the system gives me voice prompts. Can I turn these off\*?

**A:** From the Home screen, select Settings. Select System. Select the Voice Recog tab, then select Voice Prompt. Select Off.

\*if equipped

\*if equipped



**Q:** Why can't I select an item using the selector knob or touchscreen\*?

**A:** To prevent driver distraction, certain items are limited or inoperable while the vehicle is moving. Use voice commands or pull over to select the items.

**Q:** Where can I find the vehicle identification number (VIN)?

**A:** Check the label on the driver's doorjamb.

**Q:** I'm seeing an amber indicator of a tire with an exclamation point. What is that?

**A:** The Tire Pressure Monitor System needs attention. If you recently inflated or changed a tire, you have to recalibrate the system. See page 132.

## Contact Us

Honda dealer personnel are trained professionals. They should be able to answer all your questions. If you encounter a problem that your dealership does not solve to your satisfaction, please discuss it with the dealership's service manager or general manager. If you are dissatisfied with the decision made by the dealership's management, contact Honda Automobile Customer Service.

### U.S. owners

American Honda Motor Co., Inc.  
Honda Automobile Customer Service  
1919 Torrance Blvd.  
Mail Stop 100-5E-8A  
Torrance, CA 90501-2746  
Tel: (800) 999-1009

### In Puerto Rico and the U.S. Virgin Islands

Bella International  
P.O. Box 190816  
San Juan, PR 00919-0816  
Tel: (787) 620-7546

### Canadian owners

Honda Canada, Inc.  
Customer Relations  
180 Honda Blvd.  
Markham, ON  
L6C 0H9  
Tel: (888) 946-6329  
Fax: (877) 939-0909  
e-mail: honda\_cr@ch.honda.com

When you call or write, please give us the following information:

- Vehicle Identification Number
- Date of purchase
- Odometer reading of your vehicle
- Your name, address, and telephone number
- A detailed description of the problem
- Name of the dealer who sold the vehicle to you

\*if equipped

## Honda Roadside Assistance

24-hour emergency road service is available to you in the United States and Canada throughout your 3-year/36,000-mile warranty term. Services include jump starting, flat tire and lockout assistance, towing, and more (limitations apply).

Call (866) 864-5211 (U.S.) or (800) 465-7587 (Canada).

## Warranty Coverages

Below is a brief summary of the warranties covering your new vehicle.

**New Vehicle Limited Warranty:** Covers your new vehicle, except for the emissions control system and accessories, against defects in materials and workmanship.

**Emissions Control Systems Defects Warranty and Emissions Performance Warranty:** Covers your vehicle's emissions control systems. Time, mileage, and coverage are conditional.

**Seat Belt Limited Warranty:** Covers seat belts that fail to function properly.

**Rust Perforation Limited Warranty:** Covers all exterior body panels that rust through from the inside.

**Accessory Limited Warranty:** Covers Honda accessories.

**Replacement Parts Limited Warranty:** Covers all Honda replacement parts against defects in materials and workmanship.

**Replacement Battery Limited Warranty:** Provides prorated coverage for a replacement battery purchased from a Honda dealer.

**Replacement Muffler Lifetime Limited Warranty:** Covers a replacement muffler for the duration of the ownership.

Restrictions and exclusions apply to all these warranties. See the Warranty Manual at [owners.honda.com](http://owners.honda.com) (U.S.) for complete descriptions of each warranty, including time, mileage, and other conditional limitations.

Your vehicle's original tires are covered by their manufacturer. Tire warranty information can be found on the Warranty CD or at [owners.honda.com](http://owners.honda.com) (U.S.).

## EPA Contact Information

An owner may obtain further information concerning emission warranties or report violations of the terms of the emission warranties by contacting:

U.S. Environmental Protection Agency  
Office of Transportation and Air Quality  
Compliance Division,  
Light-Duty Vehicles Group  
Attn: Warranty Complaints  
2000 Traverwood Drive  
Ann Arbor, MI 48105  
**Email: [complianceinfo@epa.gov](mailto:complianceinfo@epa.gov)**

# VOICE COMMAND INDEX

Learn about all available voice commands to help you operate the vehicle. The system recognizes only the commands listed here. Available on vehicles with Display Audio. Press the Talk button before you say a command.

## ■ Voice Portal Commands

When you press the Talk button, the Voice Portal screen appears. Say one of the options, and follow the system prompts.

- Phone call
- Music search
- Audio
- Climate control
- Navigation\*
- Voice setting
- Voice help
- What is today's date?
- What time is it?

## ■ Navigation Commands\*

The system accepts these commands on most screens. You only need to press the Talk button once for navigation commands.

- View map
- Find place
- Find category
- Find intersection
- Recently found
- Go home
- Find address
- Find city
- Saved places
- Detour
- Stop Route

## ■ Climate Control Commands\*

The system accepts these commands on most screens.

- Climate control on\*\*
- Climate control off\*\*
- Air conditioner on\*\*
- Air conditioner off\*\*
- Defrost on\*\*
- Defrost off\*\*
- Fan speed # (#: 1 to 7)
- Temperature # degrees (#: 57 to 87°F, 18 to 32°C)
- Temperature max heat
- Temperature max cool

## ■ Phone Commands

The system accepts these commands on most screens.

- Call by number
- Call by name
- Call (number)
- Call (name)

*\*models with navigation*

*\*\*These commands toggle the function on and off, so the command may not match your intended action.*

## ■ Audio Commands\*

The system accepts these commands on most screens. Audio volume levels cannot be controlled using voice commands.

### FM/AM Radio Commands

- Audio on\*\*
- Audio off\*\*
- Radio FM
- Radio AM
- Radio tune to # FM (#: frequency, e.g., 95.5)
- Radio tune to # AM (#: frequency, e.g., 1020)
- Radio FM preset # (#: 1 to 12)
- Radio AM preset # (#: 1 to 6)

### SiriusXM Radio Commands

- Radio SXM
- SXM channel # (#: 0 to 255)
- SXM channel (channel name)
- Radio SXM preset # (#: 1 to 12)

### Song By Voice™ Commands

Available for tracks stored on an iPod or USB device.

- Music search
- List album (specify album)
- List artist (specify artist)
- List composer (specify composer)
- List genre (specify genre)
- List playlist (specify playlist)
- Play album (specify album)
- Play artist (specify artist)
- Play composer (specify composer)
- Play genre (specify genre)
- Play playlist (specify playlist)
- Play song (specify song)
- What/Who am I listening to?
- Who is this?
- What's playing?
- Who's playing?
- What album is this?

### Pandora Commands (U.S. only)

- Pandora play

### USB Commands

- USB
- USB play
- USB play track # (#: 1 to 30)

### iPod Commands

- iPod
- iPod play
- iPod play track # (#: 1-30)

### Bluetooth Audio Commands

- Bluetooth audio play (may not work on all phones)

*\*models with navigation*

*\*\*These commands toggle the function on and off, so the command may not match your intended action.*

## INDEX

ABS.....	25
Adaptive Cruise Control (ACC) with Low Speed Follow (LSF).....	25, 113
Address.....	95
Advanced Airbags.....	9
Airbags.....	9
Airbag Care.....	14
Airbag System Components.....	13
Front Airbags (SRS).....	9
Passenger Airbag Off Indicator.....	12
SRS (Supplemental Restraint System) Indicator ..	11, 12
All Wheel Drive (AWD).....	26
Android Auto.....	76
Anti-Lock Brake System (ABS).....	25, 108
Apple CarPlay.....	75
Audio Commands.....	167
Audio Operation.....	62
Android Auto.....	76
Apple CarPlay.....	75
Bluetooth Audio.....	71, 81
Color Audio System.....	66
Display Audio.....	72
FM/AM Radio.....	67, 77
HondaLink.....	73
iPod.....	68, 79
Pandora.....	70, 82
SiriusXM Radio.....	78
Sound.....	65
USB Flash Drive.....	69, 80
USB Port.....	62
Wi-Fi Connection.....	74
Auto High-Beam System.....	47
Automatic Brake Hold.....	109
Automatic Rain-Sensing Wipers.....	50
AWD.....	26
Battery.....	151
Blind spot information (BSI).....	26
Bluetooth Audio.....	71, 81
Bluetooth Audio Commands.....	167
Bluetooth Handsfreelink (HFL).....	83
E-Mail.....	91
HFL Controls.....	83, 86
HondaLink Assist.....	74
Making a Call.....	85, 89
Pairing a Phone.....	84, 88
Phonebook.....	85, 89
Siri Eyes Free.....	92
SMS Text Messaging.....	91
Speed Dial.....	85, 90
Talk Button Tips.....	87
Brake depress.....	26
Brake Fluid.....	151
Brake Hold.....	109
Brake system.....	26
Braking.....	107
Brightness Control.....	45
Carbon Monoxide Gas.....	4
Cargo Area Lights.....	46
Cargo Cover.....	40
Changing a Flat Tire.....	134
Changing Settings.....	30
Changing Wiper Blades.....	152
Charging system.....	25
Childproof Door Locks.....	38
Child Safety.....	15
Child Seat.....	17
Adding Security with a Tether.....	20
Installing a LATCH-Compatible Child Seat.....	18
Selecting a Child Seat.....	17
Climate Control System.....	59
Clock.....	61
Collision Mitigation Braking System™ (CMBS™).....	25, 119
Color Audio System.....	66
Condition Indicators.....	26
Contact Us.....	164
Cruise Control.....	27, 111
Customer Information.....	163
Customized Features.....	32
Dashboard Controls.....	2
Destination.....	95
Dialing a Number.....	85
Display Audio.....	72
Door Mirrors.....	57
Door Operation.....	38
Doors.....	35
Door/tailgate open.....	26
DOT Tire Quality Grading.....	159
Driver Attention Monitor.....	31
Driving.....	31, 100
Adaptive Cruise Control (ACC) with Low Speed Follow (LSF).....	113
Braking.....	107
Collision Mitigation Braking System™ (CMBS™).....	119
Cruise Control.....	111
ENGINE START/STOP button.....	106
Guidelines for your Utility Vehicle.....	101
Ignition.....	106
Lane Keeping Assist System (LKAS).....	117
LaneWatch™.....	121
Maximum Load Limit.....	102
Multi-View Rear Camera.....	122
Power Mode.....	106
Refueling.....	125
Remote Engine Start.....	105
Road Departure Mitigation (RDM).....	118

Towing a Trailer.....	104
Turbocharger Precautions.....	146
Vehicle Stability Assist (VSA®).....	110
Driving Position Memory System.....	56
Eco Assist System.....	110
ECON mode.....	27
Electric Power Steering (EPS).....	25
E-Mail.....	91
Emergency Engine Stop.....	131
Emergency Towing.....	131
Engine and Fuel.....	162
Engine Coolant.....	149
Engine Oil.....	146
ENGINE START/STOP button.....	106
Exterior lights.....	27, 46
Fastening a Seat Belt.....	7
Flat Tire.....	134
FM/AM Radio.....	67, 77
FM/AM Radio Commands.....	167
Fog lights.....	27, 46
Frequently Asked Questions.....	163
Front Airbags (SRS).....	9
Front Door Inner Handle.....	38
Front Seats.....	51
Fuel Information.....	125
Fuse Locations.....	137
Garage Opener.....	58
Hang-Up/Back button.....	83, 86
Head Restraints.....	53
Heated Windshield Button.....	60
HFL Controls.....	83, 86
High beams.....	27
Home Address.....	95
HomeLink® Garage Opener.....	58
HondaLink.....	73
HondaLink Assist.....	74
Honda Roadside Assistance.....	165
Hood.....	144
Ignition.....	106
Immobilizer.....	27
Information Display.....	28
Instrument Panel.....	24
iPod.....	68, 79
iPod Commands.....	167
Jump Starting.....	127
Key.....	34
Keyless Access System.....	36
Lane Departure Warning (LDW).....	25
Lane Keeping Assist System (LKAS).....	25, 117
LaneWatch™.....	121
Lap/Shoulder Seat Belts.....	5
LATCH-Compatible Child Seat.....	18
Light Bulbs.....	162
Lights.....	45
LKAS.....	117
Locking the Tailgate.....	35
Lock Tab.....	38
Low fuel.....	26
Low oil pressure.....	25
Low tire pressure.....	27
Maintenance.....	140
Battery.....	151
Brake Fluid.....	151
Engine Coolant.....	149
Engine Oil.....	146
Maintenance Minder.....	141
Safety Precautions.....	140
Service Codes.....	142
Under the Hood.....	144
Window Washer Fluid.....	151
Maintenance Minder™.....	27
Making a Call.....	85, 89
Malfunction indicator lamp.....	25
Malfunction Indicators.....	24
Map Legend.....	98
Master Door Lock Switch.....	38
Maximum Load Limit.....	102
Mirrors.....	57
Moonroof.....	42
Multi-Information Display.....	29
Multi-View Rear Camera.....	122
Music search.....	167
Navigation.....	93
Display and Controls.....	94
Entering a Destination.....	95
Home Address.....	95
Map Legend.....	98
Routing.....	98
Saved Places.....	97
Steering Wheel Controls.....	93
Street Address.....	95
Traffic.....	99
Turn-by-turn directions.....	98
One-Touch Turn Signal.....	46
On/Off Indicators.....	27
Overheating.....	129
Pairing a Phone.....	84, 88
Pandora.....	70, 82
Pandora Commands.....	167
Panic button.....	34
Parking Brake.....	26, 108
Passenger Airbag Off Indicator.....	12
Phone.....	84, 88
Phonebook.....	85, 89
PHONE button.....	83
Pick-Up button.....	83, 86
Power Mode.....	106
Power Moonroof.....	42
Power Tailgate.....	25, 39
Power Windows.....	41
Radio.....	67, 77
Rain-Sensing Wipers.....	50
Readiness Codes.....	161
Rear Camera.....	122

Rear Cargo Cover.....	40	Tire and Loading Information Label.....	155
Rear Seats.....	54	Tire and Wheel Replacement.....	155
Rear Wiper.....	50	Tire Identification Number (TIN).....	157
Refueling.....	125	Tire Labeling.....	157
Remote Battery Strength.....	126	Tire Service Life.....	156
Remote Engine Start.....	105	Tire Terminology.....	158
Remote Transmitter.....	34	Tire Pressure Monitoring System (TPMS)....	25, 132
Reporting Safety Defects.....	23	Tires.....	162
Road Departure Mitigation (RDM).....	118	Towing.....	131
Roadside Assistance.....	165	Towing a Trailer.....	104
Routing.....	98	TPMS.....	25, 132
Safety Information.....	3	Traffic.....	99
Carbon Monoxide Gas.....	4	Troubleshooting.....	163
Child Safety.....	15	Turbocharger Precautions.....	146
Handling Information.....	4	Turn-by-turn directions.....	98
Reporting Safety Defects.....	23	Turn signal.....	46
Safety Label Locations.....	22	Under the Hood.....	144
Safety Messages.....	3	USB Commands.....	167
Saved Places.....	97	USB Flash Drive.....	69, 80
Seat belt reminder.....	26	USB Port.....	62
Seat Belts.....	5	Utility Vehicle.....	101
Fastening a Seat Belt.....	7	Vehicle.....	162
Lap/Shoulder Seat Belts.....	5	Vehicle Controls.....	34
Seat Belt Inspection.....	6	Vehicle Stability Assist (VSA).....	25, 27, 110
Seat Belt with Detachable Anchor.....	8	Visual Index.....	1
Shoulder Anchor.....	7	Voice Command Index.....	166
Seat Heaters.....	60	VSA.....	25, 27, 110
Seats.....	51	Walk Away Auto Lock.....	36
Selector knob.....	83	Warranty Coverages.....	165
Service Codes.....	142	Wi-Fi Connection.....	74
Setting the Clock.....	61	Windows.....	41
Shift Lever Does Not Move.....	126	Window Washer Fluid.....	151
Shoulder Anchor.....	7	Wiper Blades.....	152
Siri Eyes Free.....	92	Wiper Operation.....	49
SiriusXM Radio.....	78		
SiriusXM Radio Commands.....	167		
Smart Entry System.....	35		
SMS Text Messaging.....	91		
Song By Voice Commands.....	167		
Sound.....	65		
Specifications.....	162		
Speed Dial.....	85, 90		
SRS (Supplemental Restraint System) Indicator 11, 12			
Steering Wheel.....	56		
Steering Wheel and Nearby Controls.....	1		
Steering Wheel Controls.....	93		
Street Address.....	95		
Supplemental Restraint System (SRS).....	25		
System message.....	26		
Tailgate.....	35, 39, 40		
Tailgate open.....	26		
Talk button.....	83, 86		
Talk Button Tips.....	87		
Text Messaging.....	91		
Tire Information.....	154		
DOT Tire Quality Grading.....	159		

This page intentionally left blank.

This page intentionally left blank.

## DISCLOSURES

### ■ California Proposition 65 Warning

**⚠ WARNING:** Operating, servicing and maintaining a passenger vehicle or offroad vehicle can expose you to chemicals including engine exhaust, carbon monoxide, phthalates, and lead, which are known to the State of California to cause cancer and birth defects or other reproductive harm. To minimize exposure, avoid breathing exhaust, do not idle the engine except as necessary, service your vehicle in a well-ventilated area and wear gloves or wash your hands frequently when servicing your vehicle. For more information go to [www.P65Warnings.ca.gov/passenger-vehicle](http://www.P65Warnings.ca.gov/passenger-vehicle).

### ■ California Perchlorate Contamination Prevention Act

The airbags, seat belt tensioners, and CR-type batteries in this vehicle may contain perchlorate materials—special handling may apply. See [www.dtsc.ca.gov/hazardouswaste/perchlorate/](http://www.dtsc.ca.gov/hazardouswaste/perchlorate/) for more information.

### ■ End User License Agreement

Your vehicle comes equipped with software, which is governed by the End User License Agreement in this vehicle's Owner's Manual, and which contains a binding arbitration clause. Please refer to the End User License Agreement for the terms and conditions governing your use of the installed software, as well as the applications, services, functions, and content provided through the software. Your use of the installed software will serve as your consent to the terms and conditions of the End User License Agreement.

You may opt out of the arbitration provisions within 30 days of your initial use of the Software by sending a signed, written notice to HONDA at American Honda Motor Co., Inc. Honda Automobile Customer Services Mail Stop 100-5E-8A, 1919 Torrance Blvd. Torrance, CA 90501-2746